

# Accepted Manuscript

A review on process capabilities of electrochemical micromachining and its hybrid variants

Krishna Kumar Saxena, Jun Qian, Dominiek Reynaerts



PII: S0890-6955(18)30024-5

DOI: [10.1016/j.ijmachtools.2018.01.004](https://doi.org/10.1016/j.ijmachtools.2018.01.004)

Reference: MTM 3323

To appear in: *International Journal of Machine Tools and Manufacture*

Received Date: 10 July 2017

Revised Date: 17 January 2018

Accepted Date: 21 January 2018

Please cite this article as: K.K. Saxena, J. Qian, D. Reynaerts, A review on process capabilities of electrochemical micromachining and its hybrid variants, *International Journal of Machine Tools and Manufacture* (2018), doi: 10.1016/j.ijmachtools.2018.01.004.

This is a PDF file of an unedited manuscript that has been accepted for publication. As a service to our customers we are providing this early version of the manuscript. The manuscript will undergo copyediting, typesetting, and review of the resulting proof before it is published in its final form. Please note that during the production process errors may be discovered which could affect the content, and all legal disclaimers that apply to the journal pertain.

## **A review on process capabilities of electrochemical micromachining and its hybrid variants**

Krishna Kumar Saxena, Jun Qian, Dominiek Reynaerts \*

Micro-Precision Engineering Group, Department of Mechanical Engineering, Division PMA,  
KU Leuven, Leuven-3001, Belgium

Member Flanders Make, Leuven, Belgium

\*Corresponding author: [dominiek.reynaerts@kuleuven.be](mailto:dominiek.reynaerts@kuleuven.be)

## A review on process capabilities of electrochemical micromachining and its hybrid variants

### Abstract

Electrochemical micromachining (micro-ECM) is an unconventional micromachining technology that has capability to fabricate high aspect ratio micro-holes, micro-cavities, micro-channels and grooves on conductive and difficult-to-cut materials. Both academia and industry have the consensus that it offers promising machining performance especially in terms of high surface finish, no tool wear and absence of thermally induced defects. Furthermore in order to machine novel materials with extreme properties, novel hybrid electrochemical micromachining technologies are under development. With these hybrid micro-ECM technologies, capabilities of micro-ECM can be expanded by combining it with other processes. To fully exploit the potential as well as improve micro-ECM technology and related hybrid processes, a wide spectrum of multidisciplinary knowledge is needed. The present review systematically discusses process capabilities and research developments of electrochemical micromachining and its hybrid variants considering knowledge of both basic and applied research fields. After few introductory review articles in prior state of the art, this review fills an important gap in research literature by presenting first time an extended literature source with a wide coverage of recent research developments in electrochemical micromachining technology and its hybrid variants. This paper outlines the research and engineering developments in electrochemical micromachining technology and its hybrid variants, review of the related concepts, aspects of tooling, advanced process capabilities and process energy sources. It also provides new sights into technological understanding of micro-ECM technology which will be helpful in future engineering developments of this technology.

**Keywords:** Micro-ECM, Micromachining, pulsed – electrochemical micromachining, hybrid-ECM, hybrid micro-ECM,

### 1. Introduction

The trend of product miniaturization alongwith advent of novel materials with extreme properties has posed a challenge for machining industry [1]. The demand for fabrication of micrometer scale features on variety of materials with stringent requirements on tolerances [2], shape control and metallurgical constraints has focused research on expanding the capabilities of existing micromachining technologies and development of novel hybrid micromachining technologies. This includes development of miniaturized machine tools, exploring advanced process capabilities, fabrication of high aspect ratios, knowledge of process-material interaction, effects of scaling on material processing, etc. [3]. The key applications in different sectors demanding developments in micromachining are cooling holes in gas-micro turbines, fuel injection nozzles, MEMS, components of wrist watches, MEMS, biochips, opto-electronic components, nuclear reactor components, inkjet nozzles, printed circuit boards, microfluidic channels, surgical micro-tools, micro-dies, implants, etc. In micromachining domain, the application of mechanical micromachining processes such as micro-milling, micro-turning etc. is limited by the hardness of workpiece material and issues such as tool failure, excessive tool

wear, chatter and limited surface quality. Among non-conventional micromachining technologies, micro-EDM is a commercialized technology which has capability to machine micro-dimensional features on conductive materials irrespective of hardness. It suffers from the problems with surface integrity owing to the thermally induced defects. Process repeatability and capability is very low for features smaller than 100  $\mu\text{m}$ . Laser beams wins when it comes to micromachining in non-conductive materials which are beyond the capability of electrical micromachining techniques. Also, laser beam micromachining is an electrodeless machining so no tool design and fabrication is required. The use of green fiber lasers of ultrashort pulse durations has made the micromachining process easy to monitor. However, laser beam machining (LBM) and electron beam machining (EBM) are less effective for drilling in thick workpiece materials due to the limited working range of lasers. Laser beam micromachining suffers from heat affected zone, spatter and micro cracking. Use of femtosecond pulse lasers has shown very less thermally induced defects but it is very slow and cost intensive process and not suitable for mass production. Another commercialized technology, laser micro-jet has offered possibilities in clean processing of materials with reduced thermal defects. However, the technology is limited in aspect ratio and precision is limited by hydraulic jump of water-jet especially in drilling configuration.

*Table 1: Comparison of four commercially established micromachining technologies.*

	Micro-EDM	Micro-ECM	Laser micro-jet	Laser ablation
High aspect ratio features	✓	✓	✓	✗
Micromachining on nonconductive materials	✗	✗	✓	✓
Micro tool design and fabrication	✓	✓	✗	✗
Independent of hardness	✓	✓	✓	✓
Thermally induced defects (HAZ, spatter)	✓	✗	✗	✓
Micro residual stresses on workpiece	✓	✗	✗	✓
High surface finish (nm)	✗	✓	✗	✗
High MRR	✓	✓	✗	✗
Mass production	✗	✗	✗	✗

Table 1 shows comparison of four commercially available micromachining technologies. It is important to note that micro-ECM offers promising capability to fabricate high aspect ratio features without thermal defects and high surface finish can be achieved. In micro-ECM process, localized material removal is achieved by controlled anodic dissolution of workpiece. Since, the material removal occurs at atomic level, high surface finishes can be obtained. Micro-ECM technology has been foreseen as a promising technology in future. Its process capabilities and material processing window is expected to be expanded by hybridizing electrochemical process energy with other process energies. To enable the development of micro-ECM technology and its hybrid variants, a wide knowledge spectrum is required.

In this paper, we fill an important literature gap in the existing state of the art focusing extensively on updated developments in electrochemical micromachining technology and its hybrid variants considering a wide knowledge spectrum. Development of hybrid process needs knowledge of parent process and hence this review is intended to combine knowledge of electrochemical micromachining as well as micro-ECM based hybrid micromachining technologies in single manuscript. Some of the introductory review articles on electrochemical micromachining are available in references [4]–[7] which only deal with the early basic knowledge in this field. References [4], [5] reported very early introduction about localized ECM processes and were several years ago. In the work of Bhattacharya et al. [6], basics of electrochemical micromachining as well as comparison between ECM and micro-ECM were presented after reviewing 60 publications. Recent developments and several aspects were not included in the review and since then the technology has already advanced by leaps and bounds. Landolt et al. [7] reviewed fundamental chemical aspects of electrochemical micromachining including mass transport effects. They also discussed several aspects of oxide film laser lithography and fabrication of two or multi-level structures. In the work of Sen et al. [8], a review on ECM drilling was presented focusing mainly on the hole quality aspects and discussion on effect of process parameters on hole quality was presented. Several aspects such as tooling, importance of interelectrode gap, process energy sources, selection of electrolytes for machining specific material, etc. were not covered comprehensively. A recent conference review article [9] in related field gave a shallow coverage of ECM technology without detailing processes and was merely a collection of literatures on EDM and ECM. In the work of Leese et al. [10], an overview was presented considering mainly the process parameters. In our review article we present an extended review article by considering upto-date knowledge of basic and applied research fields targeting both academia and industrial audience. The paper covers comprehensively and systematically the research developments in electrochemical micromachining technology and its hybrid micromachining variants. It covers wide knowledge spectrum including almost all aspects such as fundamentals of material removal mechanism, process material interaction, electrochemical micromachining process configurations, electrolyte and tooling aspects, process energy sources and process capabilities. The review also covers electrochemical micromachining based hybrid processes. Both assisted and combined processes are discussed vividly. Figure 1 depicts the scope of this review paper. Several aspects are cross-connected and are discussed in detail in each subsection. The paper also deduces current and future research trends in this technology.

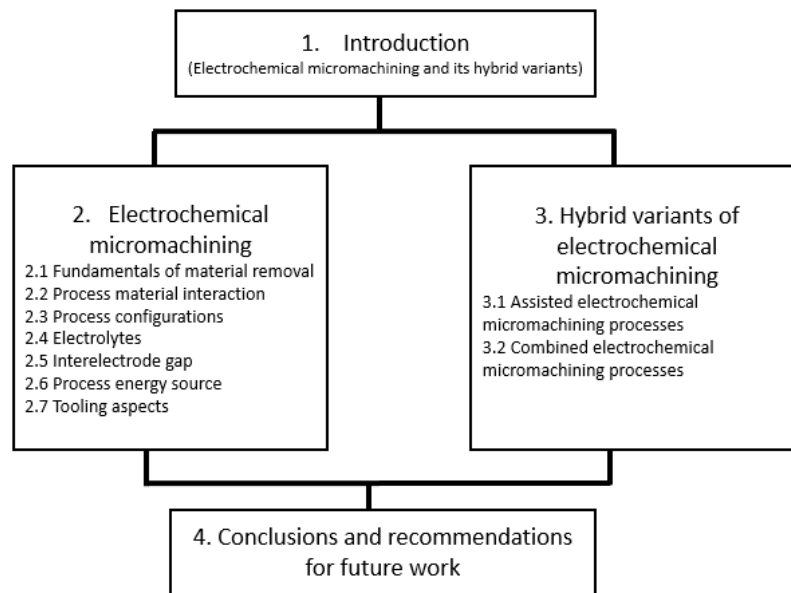

**Figure 1: Broad layout of the present review paper.**

## 2. Micro-ECM technology

Micro-ECM is an unconventional micromachining technology which finds application in wide range of sectors such as aerospace [11], automotive [12], biomedical [13]–[17], micro-electronics [18], shaver heads [19] [20], etc. The principle of material removal is anodic dissolution of workpiece as in electrochemical machining. However, in micro-ECM the goal is to localize the material removal so as to control the shape precisely. Micro-ECM technology has several advantages over other localized material removal processes. Some of them are :

- i. Independent of workpiece hardness.
- ii. Complex shapes can be machined.
- iii. It has no tool wear and high surface finish as dissolution occurs at atomic level.
- iv. It can be precisely controlled in micromachining domain through use of ultrashort pulsed power.
- v. It is a non-contact machining process so no machining forces involved and size effects don't come into picture.
- vi. It can be easily hybridized with other processes to broaden process capabilities and material processing window.
- vii. Material removal rates can be controlled from electrical parameters (Voltage, Current) and pulse characteristics (Pulse frequency, on time, duration, duty cycle).

The experimental studies conducted till date have shown direct and simultaneous involvement of several process parameters on the process performance of micro-ECM. These process parameters can be grouped into six broad categories and are represented in the form of

fish-bone diagram in Figure 2. For controlled and precise material removal in micro-ECM process, it is often required to set different machining parameters at their optimal levels. Furthermore, the surface roughness and material removal rate is influenced by pulse duration, applied voltage, pulse frequency, electrolyte concentration and tool feed rate. The general effect of different process parameters on the process performance characteristics during micro-ECM process is summarized in Table 2.

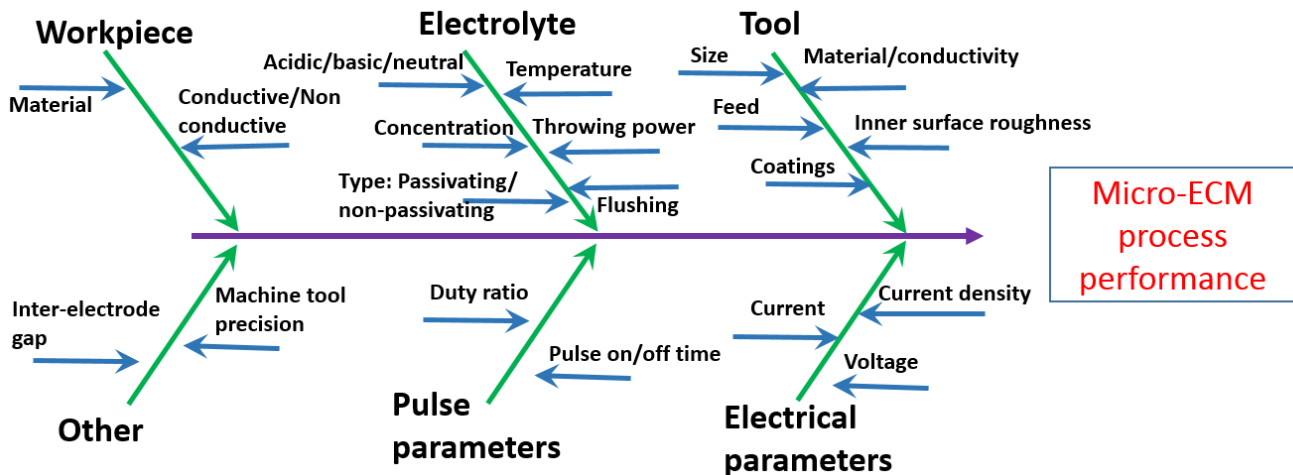

Figure 2: Ishikawa diagram representing the parameters which affect the process performance in electrochemical micromachining process.

Table 2: Overview of the effect of key process parameters on the process performance in micro-ECM ignoring the slight non-linearities in behavior. (Compiled from references [21]–[23])

	MRR	Surface finish	Shape precision	Machining gap
↑ Voltage	↑	↓	↓	↑
↑ Pulse on-time	↑	↓	↓	↑
↑ Electrolyte concentration	↑	↓	↓	↑
↑ Duty cycle	↑	↓	↓	↑
↑ : represents increasing trend ↓ : represents decreasing trend				

## 2.1 Fundamentals of material removal

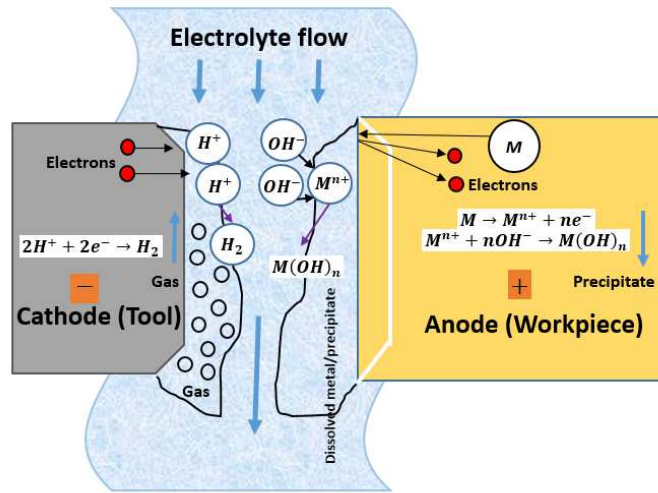
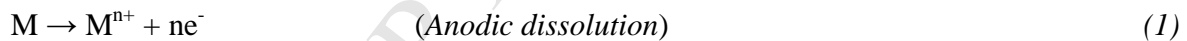

Figure 3: Pictorial representation of electrochemical activity in the inter-electrode gap during electrochemical machining.

The material removal in ECM is achieved through controlled anodic dissolution of workpiece. The workpiece is made as anode and the tool electrode is made as cathode. At the anode, the metallic workpiece (M) undergoes oxidation thereby releasing the electrons. The reaction is known as anodic reaction and is represented as [24]:



where n represents the number of electrons released during reaction. Besides anodic dissolution, oxygen evolution takes place when passivating electrolytes (E.g. aq.  $\text{NaNO}_3$ ) are used. The reaction is represented as:



In case of non-passivating electrolytes (E.g. aq.  $\text{NaCl}$ , aq.  $\text{NaBr}$ ), the evolution of halogen gases takes place (Eq. 3). The gas evolution at anode reduces the current efficiency of ECM process as it consumes major fraction of machining current and only small fraction of current is utilized effectively in dissolution.

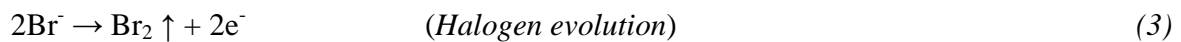

At the cathode, the water from the electrolyte dissociates into hydroxyl ions and hydrogen evolution takes place (Eq. 4). These hydroxyl ions react with the metallic ions produced during anodic reaction and precipitate as sludge which affect the stability of ECM process especially in



high aspect ratio machining (Eq. 5). To minimize the sludge precipitation, use of acidic electrolytes is recommended [25].

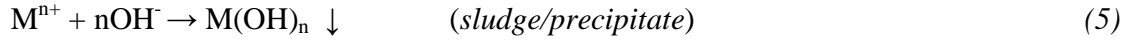
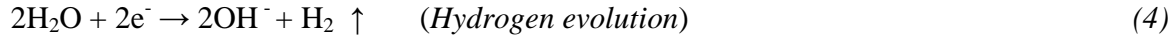

The electrochemical activity occurring between tool and the workpiece during electrochemical machining is represented pictorially in Fig. 3.

The material removal during ECM is governed by Faraday's Laws of electrolysis (Eq. 6) with current densities of about 20 to 200 A/cm<sup>2</sup> in case of ECM and 75 to 100 A/cm<sup>2</sup> in case of micro-ECM [6]. The material removal rate depends on the electrochemical properties of metal, properties of electrolyte and the electric current supplied (Eq. 6). In case of alloys, the volumetric MRR ( $V_{MRR}$ ) depends on the electrochemical equivalents and percentage of individual components of an alloy in addition to the current (Eq. 7).

$$V_{MRR} = \frac{m}{t\rho} = \eta \frac{IA}{\rho zF} \quad (6)$$

$$V_{MRR\_alloys} = \eta \frac{1}{F\rho} \cdot \frac{I}{\sum_{i=1}^n \frac{c_i z_i}{A_i}} \quad (7)$$

where,  $m$ : mass of anode dissolved,  $t$ : time,  $F$ : Faraday's constant,  $A$ : molecular weight (g/mol) of workpiece (anode),  $\rho$ : density of metal,  $I$ : current,  $\eta$ : current efficiency,  $z$ : valence of workpiece (anode),  $n$ : number of alloying elements,  $c_i$ : mass fraction (%),  $z_i$ : valency of individual constituents of alloy. The current density in electrochemical machining process is affected by mass transport effects [7] which in turn affects surface finish and shape accuracy. The limited current density considering convective mass transport is given by (Eq. 8) [6]:

$$J = \frac{\nu F D C_{sat}}{\delta} \quad (8)$$

where,  $D$ : effective diffusion coefficient,  $C_{sat}$ : surface concentration and  $d$ : diffusion layer thickness.

In localized ECM configurations, material removal is accomplished by application of pulsed voltage. The material removal during pulse electrochemical micromachining with pulse on-time ( $\tau_{on}$ ) can be written as (Eq. 9) [26]:

$$V_{m-ontime} = \int_0^{\tau_{on}} \frac{CEA}{gr} dt \quad (9)$$

Where,  $V_m$ : volume of material removed,  $C$ : the electrochemical constant,  $E$ : voltage value acquired by oscilloscope,  $A$ : electrode area,  $g$ : inter-electrode gap,  $r$ : electrolyte resistivity,  $t$ : time allowed for machining. In pulse electrochemical micromachining, the effective material removal occurs only during the time ( $t^*$ ) of faradic currents. Therefore, the material removal rate can be determined as [26]:

$$V_{m-on\text{time}} = \int_{t^*}^{\tau_{on}} \frac{CEA}{gr} dt \quad (10)$$

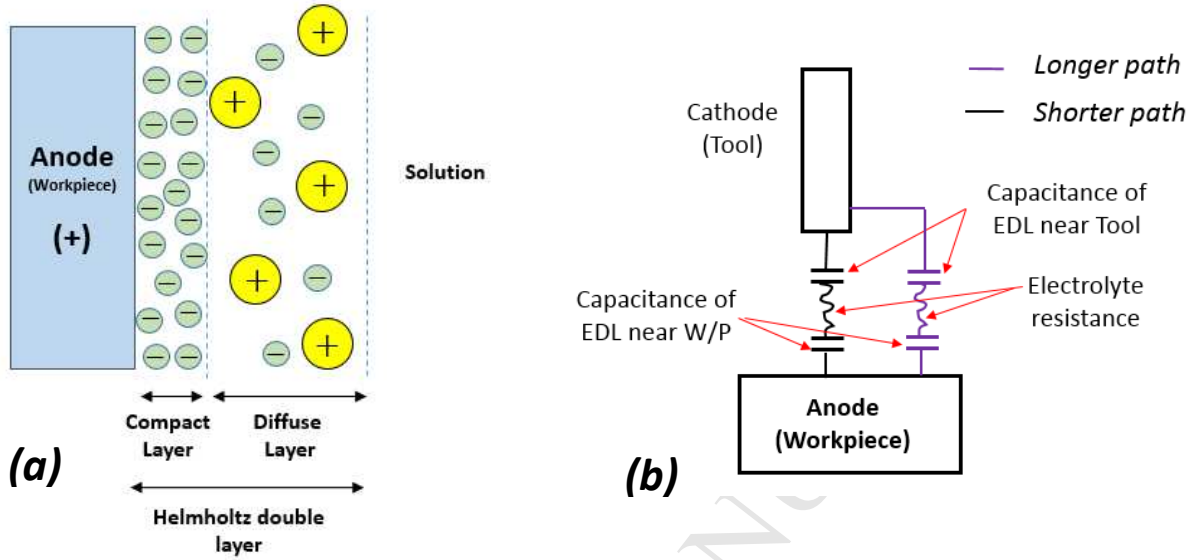

Figure 4: (a) Pictorial representation of double layer formation during electrochemical micromachining process [27]. (b) Equivalent circuit model of double layer in inter-electrode gap. Redrawn from Ref [28].

In micro-ECM, the localization of material removal is achieved by utilizing the double layer effect. Figure 4(a) depicts a pictorial representation of electrical double layer with thickness about  $11^{-10}$  m [29] formed in the inter-electrode gap which is essentially accumulation of oppositely charged ions at the metal-solution interface and it acts as an electrical barrier [27]. Because of the capacitive nature of double layer, the inter-electrode gap can be modelled as RC circuit [28]. The capacitance of electric double layer (EDL) works as an additional control parameter. The charging constant of electric double layer depends on the size of inter-electrode gap. The smaller the distance between tool and workpiece electrodes, the smaller will be the charging time of double layer capacitance [30]. By virtue of this property, better localization of material removal is achieved through the adjustment of pulse parameters according to charging constant of double layer. The charging time constant ( $\tau$ ) for the double layer is given by Eq. 11 [30].

$$\tau = \rho cd = RC_{DL} \quad (11)$$

where  $c$  is the specific capacitance of double layer, product of specific electrolyte resistivity ( $\rho$ ) and gap between electrode and workpiece ( $d$ ) gives electrolyte resistance ( $R$ ). Thus, charging time depends on the gap distance between the electrodes.  $C_{DL}$  is the overall capacitance of the double layer. When potential ( $\phi_0$ ) is applied, the charged potential ( $\phi_c$ ) in the double layer is [30]:

$$\phi_c(t) = \phi_0 \left( 1 - \exp\left(-\frac{t}{\tau}\right) \right) \approx \phi_0 \frac{t}{\tau} \quad (12)$$

From Butler-Volmer equation, during the chemical reaction, current is

$$i = i_0 \exp(\alpha f \phi_c) \approx i_0 \exp\left(\alpha f \phi_0 \frac{t}{\rho c d}\right) \quad (13)$$

where  $i_0$ : exchange current density,  $\alpha$ : transfer coefficient,  $f = F/RT$ ,  $F$ : Faraday's constant,  $R$ : gas constant and  $T$ : temperature. It is evident from Eq. 13 that current depends on applied voltage, pulse duration, electrolyte concentration and inter-electrode gap. Furthermore, the material removal rate depends on current and hence it can be controlled by the parameters in Eq.13.

## 2.2 Process-material interaction

As compared to other micromachining techniques, in electrochemical micromachining there is no change in properties of workpiece material in the vicinity of machining zone. This is solely because of the electrochemical dissolution phenomenon and absence of any thermal effects as in case of laser and micro-EDM processes. As proposed by Klocke et al. [31], in electrochemical machining the energy source is considered as a moving voltage source and major material loadings are electrical field and chemical potential at all scales [32]. Figure 5 shows the pictorial representation of the major material loadings in electrochemical machining process and their interaction with workpiece surface [32]. It is the effect of chemical potential which causes growth of thin passivation layer on the workpiece during ECM with passivating electrolytes. The uneven distribution of electric field in the inter-electrode gap causes non-uniform dissolution as shown in Fig. 6. The other process related material modifications are caused by the electrolyte flow. The flow grooves can be visualized on the ECMed surface as shown in Fig. 6. There are no stress-strain based loadings on ECMed surface as the wall shear stress of electrolyte boundary is low in magnitude.

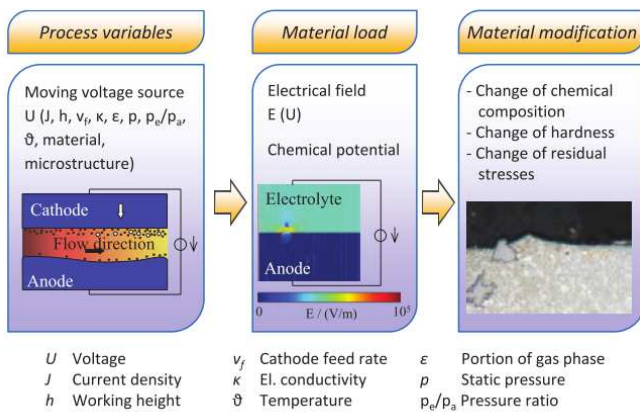

**Figure 5: Methodology to describe electrochemical machining process signature by identification of material loadings and corresponding material modification. Reproduced from Ref [32].**

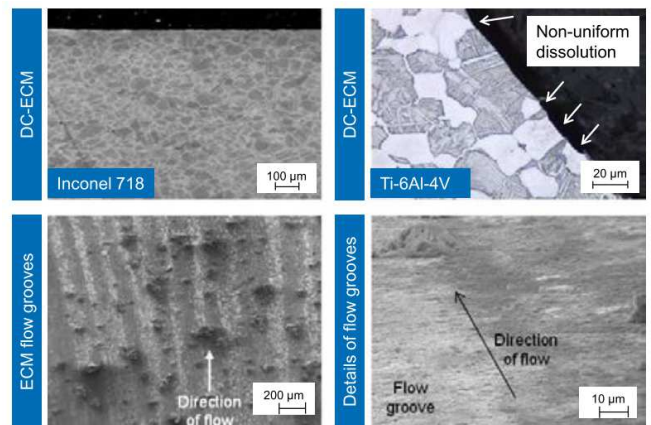

**Figure 6: Microscopic images showing material modifications: flow grooves and local dissolution during direct current electrochemical machining. Reproduced from Ref [32].**

## 2.3 ECM configurations for micromachining

### *Micro-ECM drilling/milling*

The use of small diameter tubular electrodes [33]–[36], ultrashort pulsed power supply[37]–[39], smaller inter-electrode gap [6], [10], [40], high resolution motion stages [41] and tool-rotation [42][43] enable the use electrochemical machining to fabricate micro-dimensional features with enhanced precision [44]. This falls under the domain of micro-ECM as it requires dedicated machine tool and precise control of process. Figure 7 shows sketch of micro-ECM setup with major peripherals. High aspect ratio micro-holes with complex internal shapes can be fabricated with micro-ECM technology [45]. Recently, a micro-ECM setup with granite base, gantry configuration, three linear axes and one rotary axis was reported that has capability to fabricate micro-holes [41]. This was made possible by specialized ultrashort pulsed power supply with adaptive gap control to achieve ECM in micromachining domain.

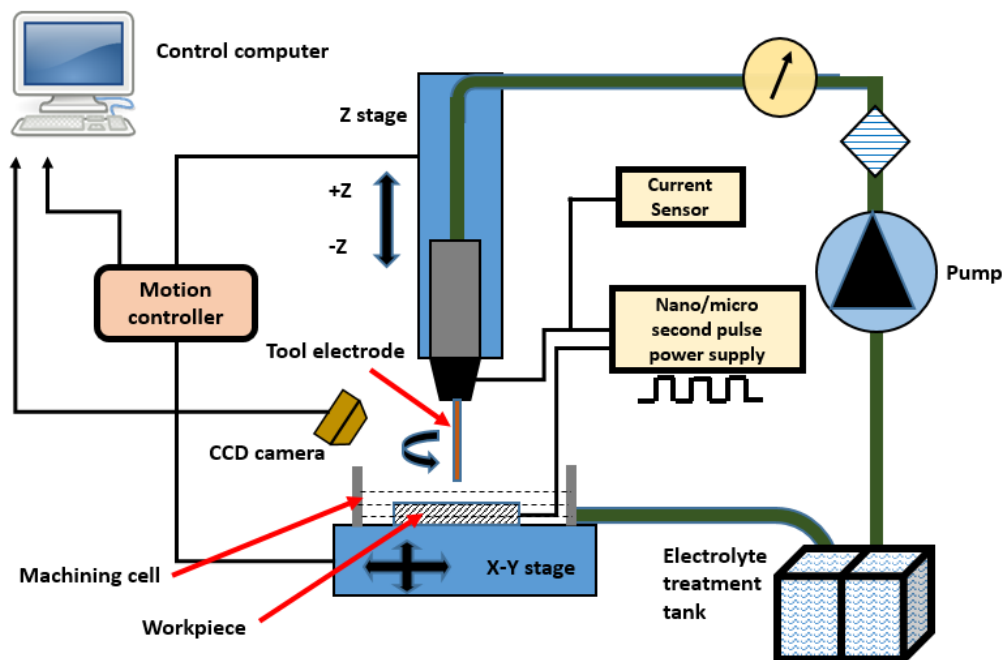

Figure 7: Sketch of a micro-ECM prototype with major peripherals.

In micro-ECM drilling, the dedicated tool-electrode is fed towards the workpiece and dissolution is made to occur in presence of high-frequency short pulsed power supply. Internal flushing is used as the side gap is very small for external flushing. During deep hole drilling, the flushing becomes difficult and the sparking phenomenon may occur due to the evolution of gas bubbles which can affect machining precision and surface integrity. To facilitate flushing at

higher depths, tool rotation is employed but this necessitates to minimize the runout as it will affect the machining precision and frequent short circuit. With the provision of advanced CAD/CAM technology together with multi-axis machining platforms, micro-ECM can be realized for milling of micro-channels [46], micro-grooves [47], microcavities [30], [48], [49]. The maintenance of required inter-electrode gap is crucial for micro-ECM process stability during machining. A lot of gap control and monitoring strategies such as adaptive control and fuzzy logic based gap control [41], short circuit detection [50], current monitoring [50]–[52], force sensing [53], use of ultrasonics [54] and machine vision [55], intelligent process models [56], etc. have been proposed in literature. Figure 8 shows the representative charging and discharging waveforms during electrochemical micromachining. During micro-ECM process, the current passing through double layer (Figure 4) is sum of two currents: non-Faradaic (capacitive current) and Faradaic current. The capacitive current, or the current used in charging the capacitors of the electric double Layer (EDL) must be overcome before faradic current can reach effective levels and produced the desired machining effect [57]. This sets an optimal pulse width in a sense that the pulse width should be long enough to charge the double layer capacitance and short enough for achieving localized material removal. Only Faradaic currents participate in dissolution and are responsible for machining. It is not straight-forward to determine the Faradaic currents and requires intensive modelling efforts [58].

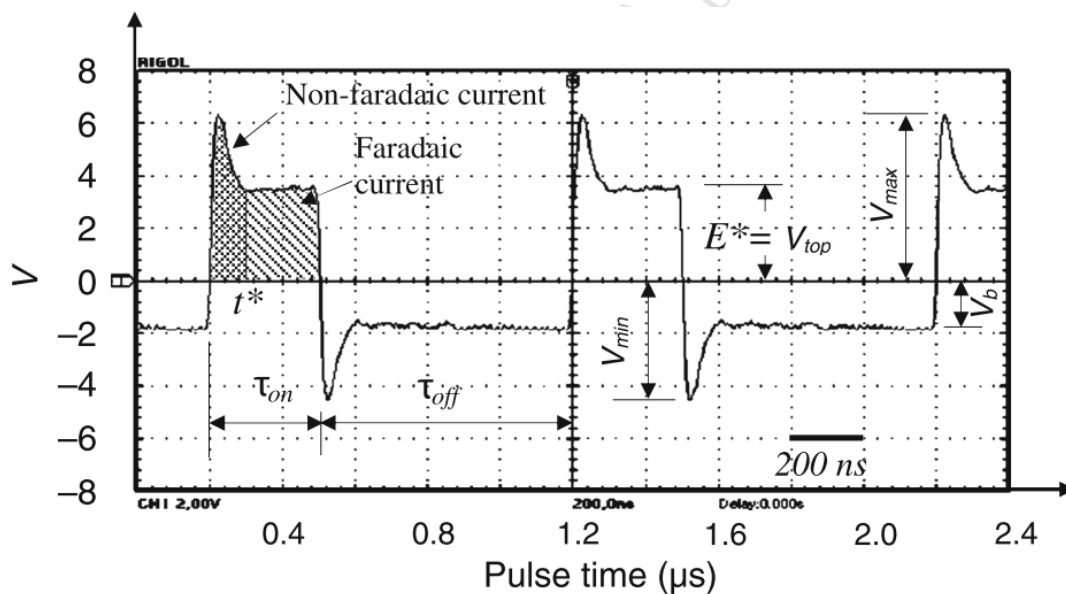

Figure 8: Charging and discharging waveforms during electrochemical micromachining. Adapted from Ref [58].

#### Jet micro-ECM

The jet micro-ECM technology enables fast production of complex surficial geometries of micro-scale dimensions [59]–[61]. The material removal from metals is achieved by concentrating the DC current in an electrolyte jet which is ejected from a nozzle at about 20 m/s [60]. This nozzle works as a cathode and workpiece is made anode. The current density of the process is about  $1000 \text{ Acm}^2$ . The surface roughness of machined surface is higher at lower current densities and the surface roughness decreases at higher current densities [62].

In order to achieve high current density, high working voltage and high conductivity electrolytes are employed. Both pulsed and DC power supply can be used as current is confined to the area of jet. Figure 9(a) shows the sketch of jet micro-ECM set up [60]. The geometric accuracy depends on the jet diameter. The accuracy of jet micro-ECM process is strongly affected by the shape of the jet but it is difficult to predict during experimentation and requires extensive modelling efforts [63]. The air assistance is found to improve the machining precision by removing the electrolyte film surrounding the nozzle [64]. The material removal can be controlled by electric current and nozzle diameter and position. It has been reported that jet micro-ECM produces higher material removal as compared to pulsed ECM process. With the jet micro-ECM, it has been possible to use ECM for micromachining by restricting the current in the jet. Jet micro-ECM can be used to fabricate micro-structured surfaces and complex three-dimensional micro geometries by changing the nozzle position and choosing proper current setting [65]. Figure 9(b) shows the localized point erosions generated by jet micro-ECM technology for machining time of 2s. An important parameter which affects the cavity widths and depths is nozzle speed. Figure 9(c) shows the variation of cavity depths with nozzle speed [66]. It can be observed that the cavity depths are higher at lower nozzle speeds due to increase in specific dissolution volume. The trend is same for all kinds of steels. However, the cavity depths are also dependent on composition of steel. Finite element based Multiphysics modelling [63] and energy distribution modelling [61] have been used for improved understanding of the physics of jet micro-ECM process.

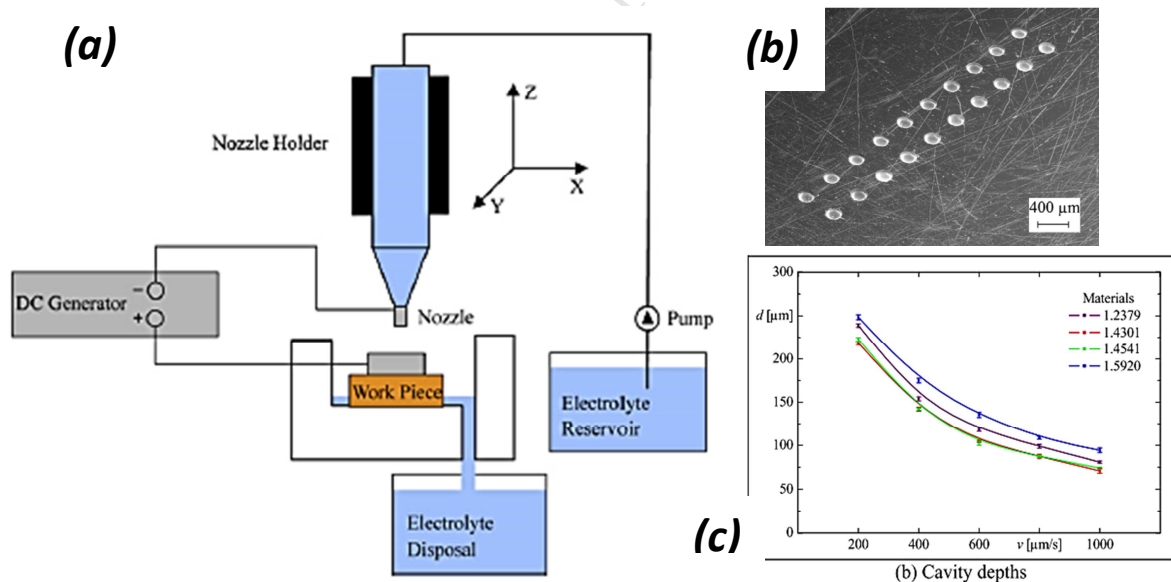
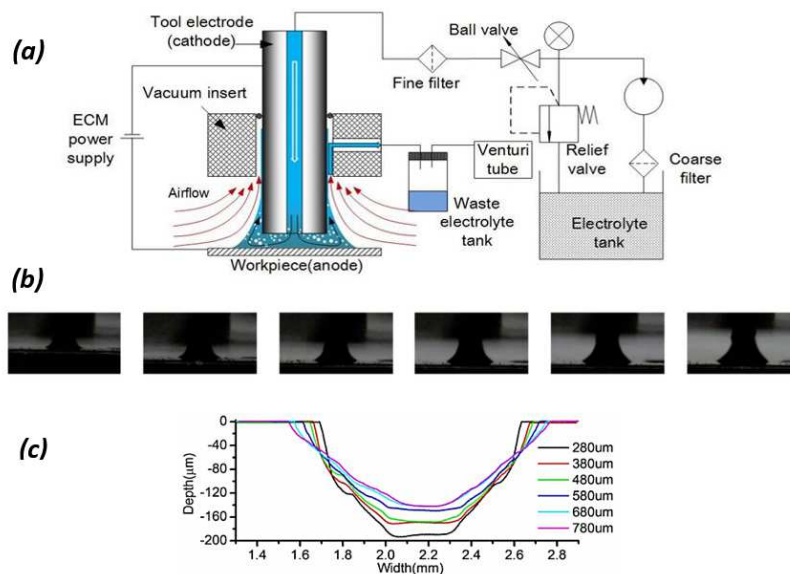

Figure 9: (a) Sketch of jet electrochemical micromachining setup [60]. (b) Point erosions produced by jet electrochemical micromachining [60]. (c) Cavity depths as a function of nozzle speed for different grades of steel [66].

### Scanning micro electrochemical flow cell based ECM (SMEFC)

SMEFC [67] has been demonstrated as a localized ECM process for surface micromachining and finishing process (Fig. 10(a)). It can confine the electrolyte to a small droplet which thereby permits localization of material removal. The SMEFC system consists of an electrolyte circulation system, a hollow tool electrode and a vacuum insert connected to a Venturi tube via an electrolyte recycling tank. The mechanism of electrolyte circulation is that the electrolyte is pumped through the hollow electrode and then it arises along the electrode outer wall by the surrounding flowing air induced by the Venturi effect, resulting in a droplet between the electrode and the workpiece, where electrochemical reactions occur. This method maintains the electrolyte of the droplet fresh and confines the electrolyte in the region of interest. The important parameter in micro-ECM with SMEFC is vacuum gap which affects the droplet shape and hence the precision of machining. This can be visualized from Fig. 10(b) and 10(c). As the vacuum gap increases, the droplet meniscus becomes wider and the cavity width increases more as compared to depth. Because of its special electrolyte circulation, there is no need for the workpiece to be immersed in the electrolyte, enabling SMEFC being an integral and flexible technique. The fabrication of mesoscale cavities [67], channels [68] and finishing of EDMed surface [69] has been demonstrated by this technique.



**Figure 10:** (a) Schematic diagram of scanning micro electrochemical flow cell. (b) Microscopic image of the electrolyte droplet under different vacuum gaps (from left to right, VG=180  $\mu\text{m}$ , 280  $\mu\text{m}$ , 380  $\mu\text{m}$ , 480  $\mu\text{m}$ , 580  $\mu\text{m}$ , 680  $\mu\text{m}$ , 780  $\mu\text{m}$ ). (c) Cross section profiles of cavities at different vacuum gaps (Current: 400 mA, t: 8 s, IEG: 50  $\mu\text{m}$ , electrolyte conc. 250 g/l) . Adapted from Ref [67].

## Wire micro-ECM

Wire electrochemical machining [70] is similar to Wire-EDM where a wire is used as a tool to cut the thick and hard workpiece material. The principle of material removal is anodic dissolution of workpiece in the presence of electrolyte unlike the spark erosion in wire-EDM process. Figure 11(a) shows the sketch of wire-ECM set-up with major peripherals [71]. The electrode or wire tool is fed towards the workpiece until the machining gap is suitable to initiate the required electrochemical dissolution. The absence of thermally induced material removal makes the wire-ECM process promising as there is no recast layer and heat affected zone. Furthermore, it doesn't compromise with the mechanical properties of high aspect ratio feature after machining. The wire doesn't undergo dimensional change or wear during wire-ECM and can be reused. The electrolyte can be conveniently supplied to the machining zone without needing complex electrolyte supply system. The potential candidate materials for wire of wire-ECM process are tungsten, copper and platinum [72]. The accuracy in wire-ECM depends mainly on machining gap which depends on feed rate of wire, pulse voltage and pulse on-time [71]. Figure 11(b) shows the variation of machining gap with wire feed rate. It is evident that machining gap reduces with an increase in feed rate and this improves machining accuracy. On the contrary, machining gap increases with an increase in pulse voltage and pulse on time, thereby deteriorating process accuracy. Workpiece vibration and optimum wire- travel speed are reported to generate improved surface finish during micro wire-ECM process [73].

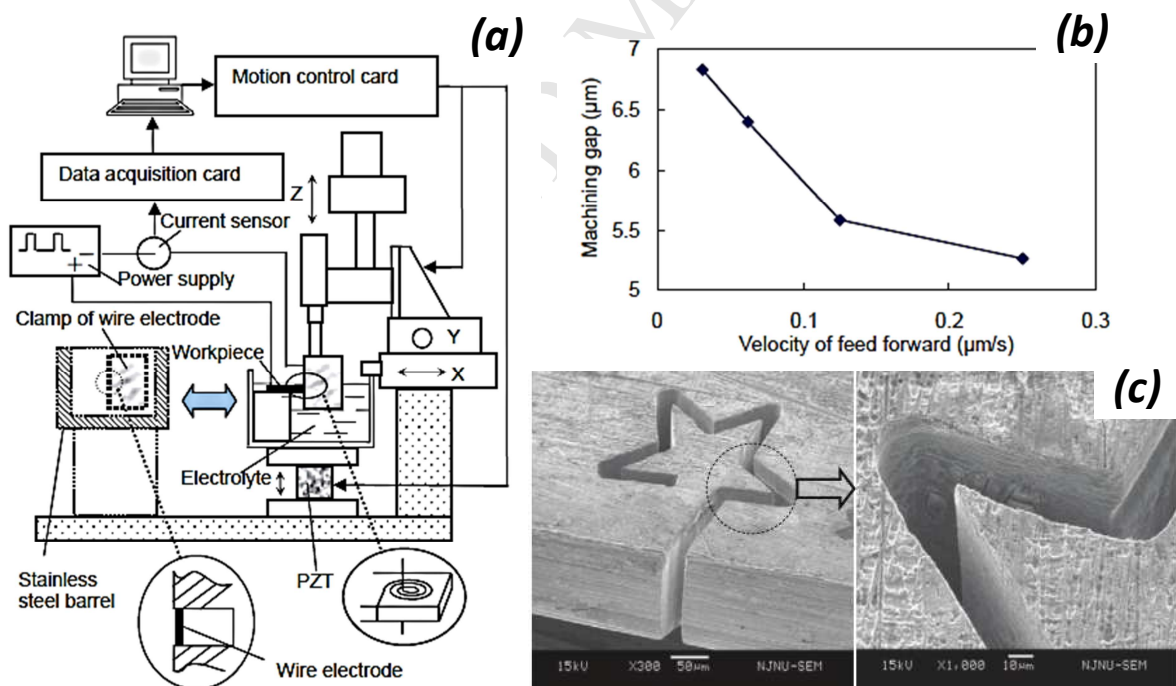

Figure 11: (a) Sketch of wire electrochemical machining setup. (b) Variation in machining gap with feed rate (electrode diameter:  $10 \mu\text{m}$ , pulse period:  $1 \mu\text{s}$ , electrolyte:  $0.1 \text{ M HCl}$ ) (c) Microstructures fabricated by micro wire electrochemical machining. Adapted from Ref [71].



To increase the productivity, multi-wire electrochemical machining process [70] is also employed where the axial flushing of electrolyte is employed to fabricate multiple features simultaneously. A special fixture is used to align the axes of the wires in same plane. The wires traverse same trajectory at constant feed-rate during cutting into the workpiece. Figure 11(c) shows the microstructures with slit width 20  $\mu\text{m}$  fabricated by micro wire electrochemical cutting at feed rate of 0.125  $\mu\text{m/s}$ , 50 ns pulses of 4.2 V [71].

#### *Compilation of applications and process capabilities of micro-ECM*

Electrochemical micromachining presents a broad field of application in aerospace industry [74]–[77], automotive industry [12], biomedical industry [13]–[17], [78], consumer products [19][20], machining of dies and tools [79], machining of difficult-to-cut materials [11], [25], [80]–[86], in process dressing of grinding wheels [87] and other fields [4], [88]–[94] as compiled in Table 3. Figure 12 gives a pictorial overview of potential industrial applications where electrochemical micromachining is applied for machining at micro or sub millimeter scale. Table 3 summarizes the process capabilities and workpiece materials investigated for different configurations of electrochemical micromachining as compiled from different literature sources. Table 5 presents compilation of advanced process capabilities of electrochemical micromachining in different configurations. The main materials which have been widely researched for machinability using electrochemical micromachining are Titanium alloys, superalloys and steels. Tables 6, 7 and 8 present studies conducted on electrochemical machining of Titanium alloys, superalloys and steels respectively alongwith the tool-electrolyte combinations and respective machining conditions. This will be helpful for practicing engineers.

**Table 3: Potential application areas of electrochemical machining at micrometer and sub millimeter scale.**

Application sector	Products/feature
Aerospace industry	High aspect ratio straight, inclined and turbulated cooling holes for turbine blades, functional apertures in aerospace components, manufacturing of aerodynamic seals, gearwheels, turbine blisks, texturing for generation of superhydrophobic surfaces. (Courtesy: Indec <sup>TM</sup> , PEMTec®)
Automotive industry	Micro-holes in fuel injection nozzles and apertures for oil inlet in bearings, gearwheels and cog wheels, turbocharger components (Courtesy: Indec <sup>TM</sup> , PEMTec®)
Medical/biomedical industry	Micro-needles for cochlear implants, sharp edged and high finish surgical tools, optical quality finished dies and moulds for surgical tools, punches for tablets
Consumer products	Shaver heads (finishing and grooving) (Courtesy: Philips®), hydrophobic surfaces, surfaces with high surface finish requirement
Chemical industry	Micro heat exchangers, micro-reactors (Courtesy: ECM technologies®)
Tooling	Cutting tool inserts, dies and punches, embossing tools, coin stamps
General applications	Micro-holes, micro-channels, micro-slots, micro-cavities, complex internal and external shapes on difficult to cut materials such as titanium, stainless steel, superalloys, heavy metals, etc.

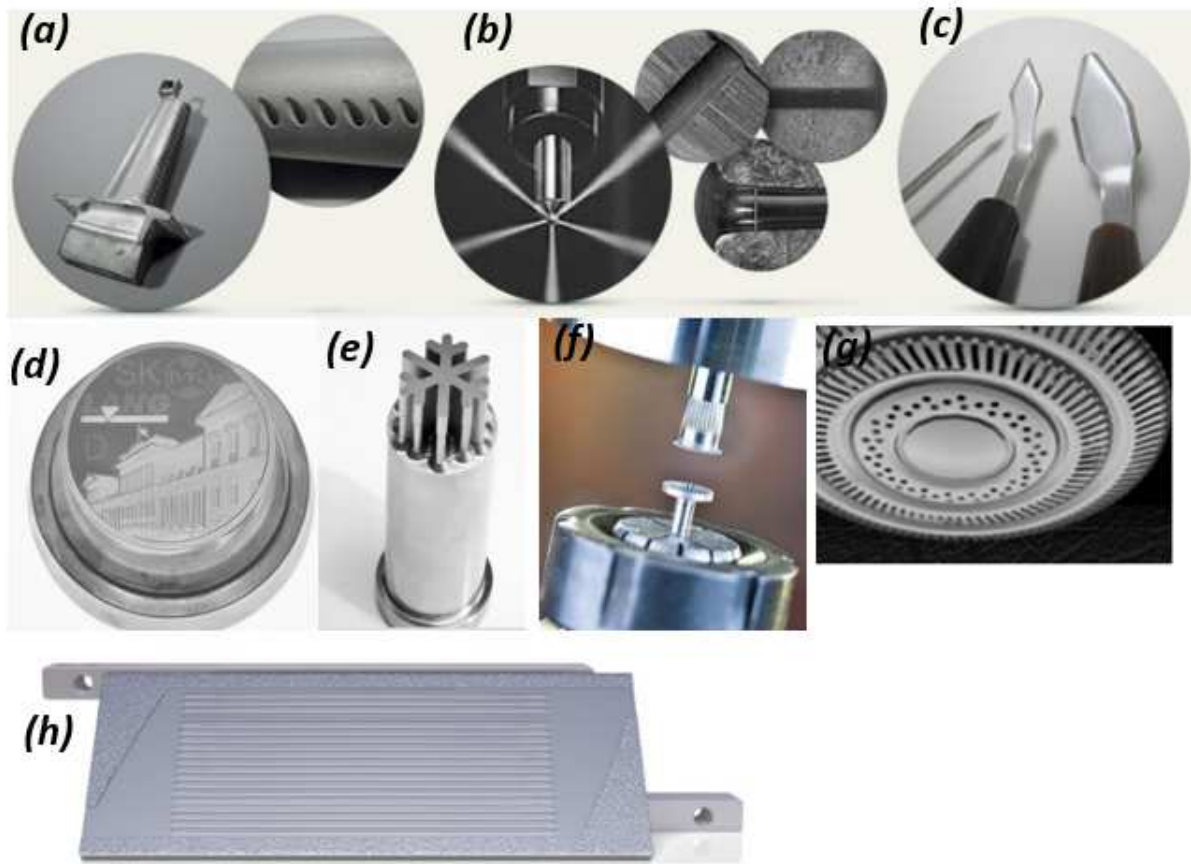
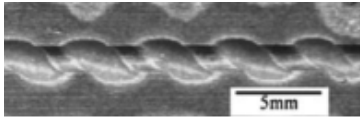
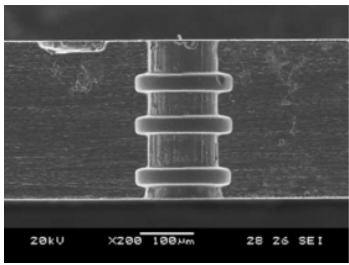
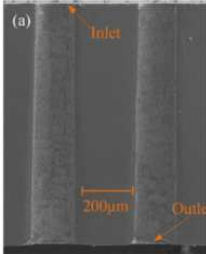
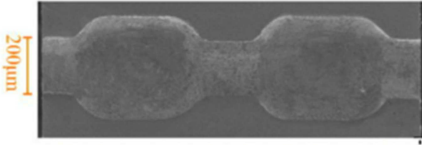

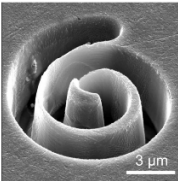

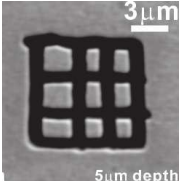
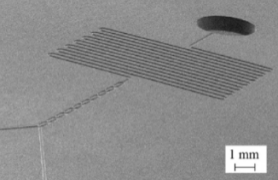
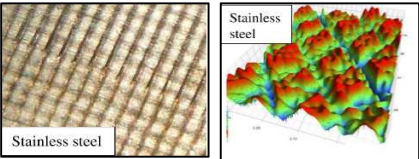
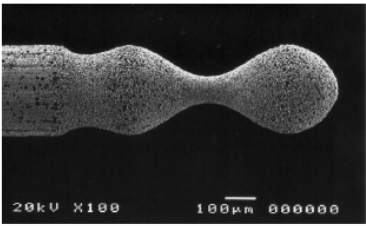

**Figure 12: Potential industrial applications of electrochemical micromachining. (a) Cooling and functional apertures in turbine blades for aerospace industry. (b) Micro-holes and apertures in fuel injection nozzles (c) Formation of sharp cutting edges of medical micro-surgical tools with edge sharpness less than  $1\ \mu\text{m}$ . (Picture courtesy: INDEC<sup>TM</sup>). (d) Coining stamps for mintage industry. (e) Micro punching dies (Picture courtesy: PEMTec®) (f) Micro-gear with internal teeth for medical application (Picture courtesy: Bosch GmbH) (g) Micro-slots and high surface finish in shaver head (Picture courtesy: Philips DAP) (h) A micro heat-exchanger with heating channels' dimensions (width x depth):  $800\ \mu\text{m} \times 400\ \mu\text{m}$  (Picture courtesy: ECM Technologies®.)**

**Table 4: Research developments in different variants of electrochemical micromachining technology.**

ECMM variant	Process capabilities	Workpiece materials investigated	Research opportunities
Micro-ECM	Groove [47], texturing on flat and curved surfaces [90], [95], drilling [8], [96], milling [23], [30], [48], [49], silicon micro-structuring [97], complex internal holes [98]–[100], nanostructures [101], 3D microstructuring [102] [49],	Tungsten [103], copper [104], SS 304 [96], Single crystal Ni superalloy [75], [105], Inconel [25][83], gold [106] [107], silicon [94], [97], [108], molybdenum [109], Ni and Ti alloys [17], [82], [110], stainless steel [111] [112], WC-Co [80], SiC [113], WC [114]	<ul style="list-style-type: none"> <li>• Development of multifunctional machine tools.</li> <li>• Development of innovative process energy sources</li> <li>• Research into ecofriendly electrolytes.</li> <li>• Development of advanced process monitoring techniques</li> <li>• Advanced characterization of dissolution phenomenon especially the conditions in inter-electrode gap.</li> <li>• Improvements in multiphysics modelling of electrochemical micromachining.</li> </ul>
Jet micro-ECM	Cavities, pits and point removals [59] [64], Sharp edge production [65], grooves [62], surface texturing [115], turning [116] [117], finishing [118], cutting [119], 3D machining [120], microchannels [65], production of defined surface waviness [121]	carbides [122], stainless steel SUS 304 [62], Incoloy® [123], Nimonic® 80A [64], titanium [86], [124], Y-TiAl intermetallic [84], Particle reinforced aluminium matrix composites [125] [126], WC [127]	<ul style="list-style-type: none"> <li>• Better understanding of jet shape as it affects machining precision.</li> <li>• Development of in process metrology for jet micro-ECM.</li> <li>• Evaluation of process-product fingerprint for jet micro-ECM technology.</li> <li>• Research into novel applications including surface texturing, fabrication of microfluidic channels.</li> </ul>
SMEF	Pits and cavities [67], channels [68], finishing [69]	Stavax® mould steel[67]	<ul style="list-style-type: none"> <li>• Better understanding of electrolyte droplet shape evolution as it affects machining precision.</li> <li>• Developments of prototypes that can realize higher electrolyte flow rates.</li> <li>• Development of in-process monitoring techniques.</li> </ul>
Wire micro-ECM	Cutting [71], [73]	cobalt [73], nickel [71]	<ul style="list-style-type: none"> <li>• Development of improved electrolyte flushing systems to improve machining accuracy.</li> </ul>

**Table 5: Advanced process capabilities of electrochemical micromachining technology as compiled from different literatures.**

Process capability	Figure	Details	Reference
Spiral duct cooling passage		Controlled micro-ECM parameters – 8 V, 150 g/l, NaNO <sub>3</sub> , 0.2 MPa electrolyte pressure, 15 m/s electrolyte velocity, 10 min machining time.	[99]
Groove array in micro-hole		Fabricated using single disc electrode in micro-ECM, hole diameter 130 µm, groove depth and height 30 µm and 33 µm respectively.	[98]
Reverse tapered holes		Micro-holes with inlet diameter of 178 µm and taper angle of 1.05° on 1 mm thick 18CrNi8, can be machined by varying voltage, varying duty ratio and varying feed rate machining.	[100]
Bamboo shaped hole		Fabricated using varying feed rate machining mode on 1.0 mm-thick 18CrNi8 workpiece, internal surface roughness Ra 674 nm.	[100]
Pocket machining		Milling mode micro-ECM, fabricated using cylindrical tools, small step-over distance generates smooth surfaces.	[48]
Spiral trough		Depth of 5 mm, workpiece –Ni, tool – Tungsten, electrolyte - 0.2M HCl , parameters: 3 ns, 2 V pulses, 33 MHz repetition rate.	[38]

Micro structuring		Workpiece – Au, electrolyte – 1 M LiCl/DMSO solution, machining parameters: 4.2 V, 20 ns pulses.	[107]
Fabrication of micro-reactor		Workpiece-stainless steel 1.4541, fabricated by jet-EC milling, use of electrolytic free jet – localized machining.	[60]
Surface texturing		Processing parameters: voltage: 5 V, pulse on time: 10 μs, pulse off time: 110 μs, electrolyte: 5% NaNO <sub>3</sub> , IEG: 100 μm.	[90]
Micro-turning		ECM turning achieved by rotating the cylindrical workpiece and moving the jet along the axial direction. The profile is generated by changing current sinusoidally from 0 – 50 mA.	[116][117]
Finishing of pre-machined surface		Use of ball ended tool-electrode , electrolyte – 15% aq. solution of NaNO <sub>3</sub> , Voltage - 16V.	[128]
Banana shaped grooves and finishing	 <p>(Picture courtesy: Philips® DAP)</p>	ECM process- final step in production of shaving head, fabrication of banana shaped grooves and required surface finish accomplished by electrochemical machining.	[20]

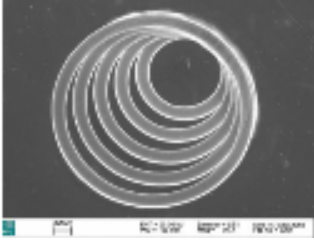
Fabrication of sharp edges		Using jet electrochemical micromachining, workpiece : Steel 1.4541, geometry consists of five coaxial circles with varying radii from 1 – 2.2 mm and number of crossings vary from 10 -50, minimal edge radius 1 $\mu\text{m}$ .	[65]
----------------------------	-----------------------------------------------------------------------------------	----------------------------------------------------------------------------------------------------------------------------------------------------------------------------------------------------------------------------------	------

**Table 6: Reported works on electrochemical micromachining of Titanium alloys.**

Ref	Tool material	Electrolyte	Experimental conditions
[129]	Copper-tungsten	aq. NaCl, aq. NaNO <sub>3</sub>	U: 10- 24 V; electrolyte flow rate: 20 dm <sup>3</sup> /min; feed rate: 1.04 mm/min
[110]	Stainless steel 1Cr18Ni9Ti	aq. NaCl (10 %)	U: 30 V, inlet pressure: 0.5 MPa, initial gap: 0.5 mm, feed rate: 0.5, 1.2 mm/min
[86]	nozzle	aq. NaCl, NaBr, NaF, NaNO <sub>3</sub>	I: 0.2 A, stand-off distance: 0.5 mm, electrolyte flow rate: 6mL/s, current density: 408 A/cm <sup>2</sup>
[130]	Pt wire	3M sulphuric acid-50% methanol- 50% ethanol	U: 10, 30 V; electrolyte temperature: -10 , 0 deg C
[70]	wire	(2.5 – 10 %) NaCl + NaNO <sub>3</sub>	U: 18-22 V, wire feed rate: 0.6 -1.8 mm/min, electrolyte flow rate: 42-87 m/s
[131]	Tungsten	NaCl, NaBr, HCl, H <sub>2</sub> SO <sub>4</sub> , NaClO <sub>4</sub> .H <sub>2</sub> O, EG+NaBr, EG+NaBr+NaCl	U: 12 V; pulse frequency: 50 kHz, duty cycle: 20 %, tool feed rate: 1 $\mu\text{m/s}$ , inter-electrode gap: 15 $\mu\text{m}$
[17]	Metallic nozzle	Aq. NaBr	U: 150, 200 V; electrolyte pressure: 175-280 kPa;
[132]	Platinum	NaCl, KBr, NaNO <sub>3</sub> at different pH	Electrolyte pH: NaCl, KBr-pH 7, NaNO <sub>3</sub> -pH 1, 7, 12
[133]	Nozzle	20 % wt. NaNO <sub>3</sub>	Nozzle inside diameter: 250, 1000 $\mu\text{m}$ ; nozzle feed: 1m/s, nozzle stand-off: 500 $\mu\text{m}$ , electrolyte flow rate: 60 ml/min; ultrasonic assistance
[84]	Stainless steel 1Cr-18Ni-9Ti	15% w/v NaCl	U: 25-40 V; electrode feed rate: 0.8 – 2 mm/min; electrolyte pressure: 0.4-1.0 MPa; electrolyte temperature: 30-45 deg C

**Table 7: Reported works on electrochemical micromachining of superalloys.**

Ref	Workpiece	Tool material	Electrolyte	Experimental conditions
[83]	Inconel® 718	Copper tube with epoxy insulation	aq. NaNO <sub>3</sub>	inlet electrolyte pressure: 0.1 MPa; outlet electrolyte pressure: 0.35MPa; electrolyte flow rate: 10ml/min; U: 6 – 14 V; tool feed rate: 0.3 – 0.6 mm/min, electrolyte concentration: 6 – 16 wt. %.
[105]	Ni based single crystalline superalloy LEK94®	Steel	aq. NaNO <sub>3</sub>	suitable current densities: 1- 4 A/mm <sup>2</sup> , electrolyte conductivity: 115 mS/cm.
[11]	Ni based	Copper tube	12.5 wt.%	U: 9V; tool feed rate: 0.9 mm/min; bare tip length:

	superalloy	with Perspex insulation	NaCl and 2.5 wt.% HCl	0.9 mm,
[123]	Incoloy® 800	Borosilicate glass nozzle	aq. H <sub>2</sub> SO <sub>4</sub>	U: 325 V; Pulse on-time: 30 µs; pulse off-time: 50 µs
[82]	Ni based superalloys	-	aq. NaNO <sub>3</sub>	U: 17.5 V; electrolyte temperature: 308 K; electrolyte concentration: 5- 20%
[85]	Inconel® 825	Copper	aq. NaCl	U: 5-15V; feed rate: 0.2 -0.6 mm/min; electrolyte concentration: 80, 95, 111.11 g/l
[134]	Inconel® 738	-	20% wt. aq. HNO <sub>3</sub>	U: 16 V, feed rates: 1.8 – 10 mm/min
[25]	Inconel®	Copper tube with Perspex insulation	1% HCl+ 10% NaCl	U: 17 V, feed rate: 1.0 mm/min
[75]	DD6-Ni® based single crystal superalloy	Brass	aq. NaNO <sub>3</sub>	U: 80 V; electrolyte pressure: 4 MPa; pulse on-time: 12 µs; pulse off-time: 30 µs; peak current: 6 A; salt solution conductivity: 3 mS/cm, Technology: ECDM
[79]	Inconel® 718	Stainless steel	aq. NaNO <sub>3</sub>	U: 30V, initial gap: 0.26 mm, tool feed rate: 0.6 mm/min
[74]	Inconel® 718	-	aq. NaNO <sub>3</sub>	U: 10 V; tool feed rate: 7 µm/s; electrolyte flow rate: 10 mL/min
[135]	Hastelloy® B-2	Tungsten	aq. HCl	Pulse duration: 25 -200 ns; tool feed rate: 1.8 µm/min; U: 1.3 V
[136]	Ni based superalloy	Tungsten	0.2 M sulphuric acid	U: 3.5 -5.5 V; pulse on- time: 40 - 150 ns; tool feed rate: 0.2 µm/s
[101]	Nickel	Tungsten	aq. HCl	U: 2V; pulse on-off ratio: 1:10; pulse on time: 2 - 100 ns

**Table 8: Reported works on electrochemical micromachining of steels.**

Ref	Workpiece material	Tool material	Electrolyte	Experimental conditions
[66]	X153CrMoV12, X5CrNi18-10, X6CrNiTi18-10, 18CrNi8	Nozzle	30 % NaNO <sub>3</sub>	U: 56 V; working distance: 100 µm; electrolyte flow rate: 10 ml/min; nozzle motion speed: 200-1000 µm/s; number of nozzle crossings: 10
[67]	Stavax® mould steel	WC-Co	aq. NaNO <sub>3</sub>	Machining current: 50 – 700 mA; Inter-electrode gap: 20 – 50 µm; Technology: SMEF based micro-ECM
[137]	Stainless steel	Nozzle	20 % NaNO <sub>3</sub>	Gap width: 1 mm; pressure: 30 MPa; current: 25 MPa; U: 30-150 V
[138]	Stainless steel	Platinum	aq. NaCl	Enhancement of ECM by 248 nm laser; laser pulse energy: 200 mJ; U: 0.5 V
[47]	304 Stainless steel	Tungsten	0.2 mol/L H <sub>2</sub> SO <sub>4</sub> solution	U: 6-9 V; pulse on-time: 75-150 ns; feed velocity: XY 2 µm/s, Z 1 µm/s
[112]	Stainless steel 1.4301	-	8% NaNO <sub>3</sub>	U: 5-14 V; feed rate: 0-0.5 mm/min; pulse on time: 1-4 ms; pulse frequency: 50 Hz; electrolyte inlet pressure: 3.1 bar
[111]	Stainless steel	Platinum	3 M HCl/6 M HF	U: 2 V; pulse on time: 10-200 ns

	1.4301			
[139]	304 Stainless steel	-	Composite electrolytes: Salt solutions + complexing agents	U: 8 V; pulse on-time: 5 $\mu$ s; pulse off time: 5 $\mu$ s; electrolyte pressure: 0.55 MPa
[140]	AISI 304 (X5CrNi18-10) is	Steel	NaNO <sub>3</sub>	U: 10 V; pulse on time: 2.5 ms; Electrolyte flow rate: 4.7 l/min, electrolyte pH: 7.1
[92]	9CrWMn alloy tool steel	Brass	10 % NaCl	U: 14-18 V; cathode feed rate: 16-20 mm/min; electrolyte pressure: 1.5-2.5 MPa

## 2.4 Electrolytes for electrochemical micromachining

In electrochemical micromachining, electrolyte serves multiple roles i.e. participating in electrochemical dissolution, maintaining process stability and flushing out reaction by-products from machining zone [6]. It is crucial to select proper electrolyte for stable micro-ECM. The selection of electrolyte depends on several aspects such as composition of material to be machined, smaller inter-electrode gap, sufficient ionic concentration, desired material removal rate and surface quality. Figure 13 gives a broad overview of electrolytes used in electrochemical micromachining. The most common types of electrolytes are aqueous salt solutions and weakly acidic solutions. Aqueous salt solutions can be passivating and non-passivating [141]. Passivating electrolytes contain oxidizing anions (NaNO<sub>3</sub>, NaClO<sub>3</sub>). Non-passivating electrolytes contain aggressive ions (NaCl). Non-passivating electrolytes are recommended when good surface finish is required. For micromachining using ECM, use of passivating electrolytes is recommended because they form a thin oxide layer which minimizes dissolution in stray current region. Therefore, passivating electrolytes are reported to give better machining precision in ECM based micromachining. However in case of deep hole drilling, sludge formation restricts the process stability and achievable aspect ratios. Therefore, pH of the electrolyte also plays an important role. In Shaped tube electrolytic machining (STEM) of deep holes, acid based electrolytes are recommended to minimize the sludge deposition [25]. The use of acidic electrolytes creates an additional challenge for tool material selection, environmental and operator safety issues. EDTA based complexing agents have been proposed as an alternative to acidic electrolytes to minimize sludge deposition [142]. For machining of WC, dissolution is possible in alkaline electrolytes, however the sludge formation leads to higher IEGs [141]. For specific metals such as titanium [131], [143] and molybdenum [109]; use of non-aqueous electrolytes is reported as these electrolytes don't lead to formation of passivation layer and surface quality is higher. For machining alloys and sintered materials; mixed electrolytes are used [80]. Some groups have also reported use of ecofriendly electrolytes such as water [144], [145] and citric acid [146] to address the environmental issue associated with safe disposal of conventional electrolytes. Tables 5-7 presents the different electrolytes used for machining of titanium alloys, superalloys and steels.



The electrolyte concentration is a major influencing factor that determines the accuracy of the process [147]. Figure 14(a) shows the effect of electrolyte concentration on MRR during electrochemical micromachining process [148]. An increase in the electrolyte concentration increases the current as well as the dissolution efficiency and hence it results in an increase in MRR [148]. However, the material removal also occurs in the stray region and deteriorates the localization of the material removal. This causes overcut thereby affecting process accuracy. It can be observed from Figure 14(b) that besides machining speed, electrolyte concentration also affects side gap [23]. The low or moderate electrolytic concentrations cause a reduction in machining gap leading to high accuracy [23]. Therefore, low or moderate electrolyte concentration are good for ECM based micromachining for localizing the material removal [6]. It is not advised to use too low concentrations as it may cause depletion of sufficient ions for electrochemical dissolution and MRR will be much lower. The throwing power of electrolyte should also be considered in electrolyte selection. Electrolytes with low throwing power are preferred for higher accuracy in micromachining domain [149]. During micro-ECM drilling, the flushing of electrolytes becomes difficult at higher depths and thus the machining by-products (debris, bubbles, gases) are not effectively removed leading to problems with machining accuracy. Use of tubular electrodes for internal flushing at higher depths is recommended [34]. Use of vacuum extraction of electrolyte has been proposed to localize the machining process and minimize overcut during drilling [150]. Multiple holes have also been drilled using vacuum extraction of electrolyte in ECM [151]. For improvement of heat and mass transfer in the ECM gap and improving the MRR, pulsating electrolyte flow has been proposed [152]. It has been reported that a constant electrolyte flow rate improves the hole profile in ECM drilling [153]. Increase in electrolyte pressure improves flushing of electrolyte and improves accuracy in ECM drilling [34]. The use of ultrasonic vibrations in electrolyte [154] and tool jump motion [155] has been reported to increase machining depth and improved flushing conditions while fabricating deep holes. To ensure good surface finish and minimize electrolyte boiling, the temperature of electrolyte should be controlled properly [152], [156]–[158]. The temperature of the electrolyte affects the electrolytic conductivity depending on the type of electrolyte. Jain et al. [159] performed in-depth modelling and experimental investigations on the variation of electrolytic conductivity in machining zone due to gas evolution and sludge formation. It was reported that if the IEG is very small ( $< 200 \mu\text{m}$ ), the electrolyte conductivity reduces by more than 20% at 10 V.

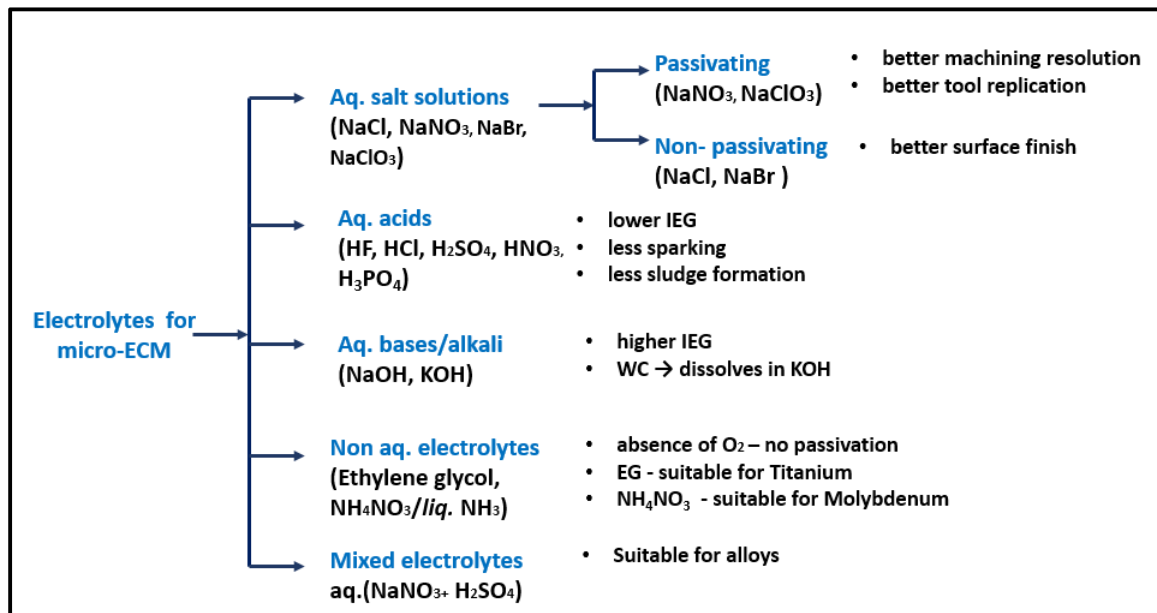

Figure 13: Overview of electrolytes used in electrochemical micromachining along with primary characteristics.

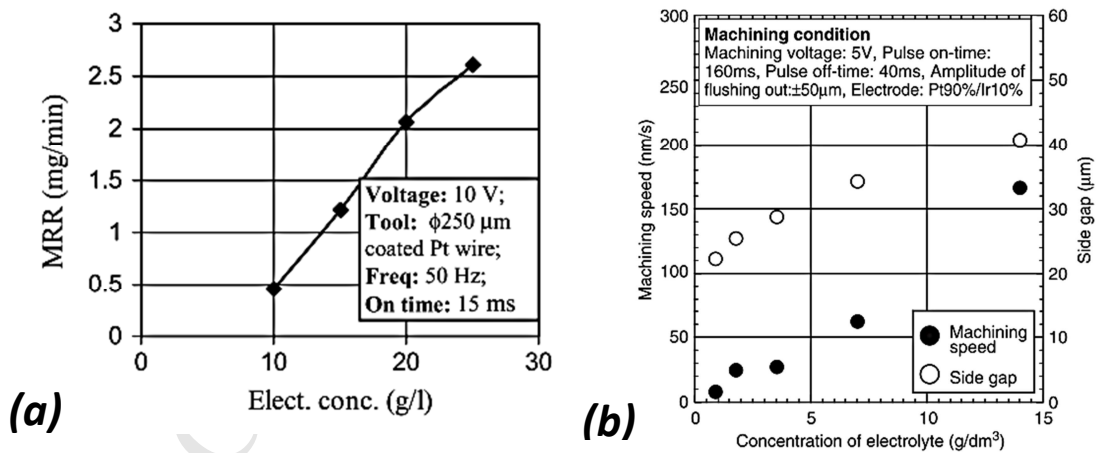
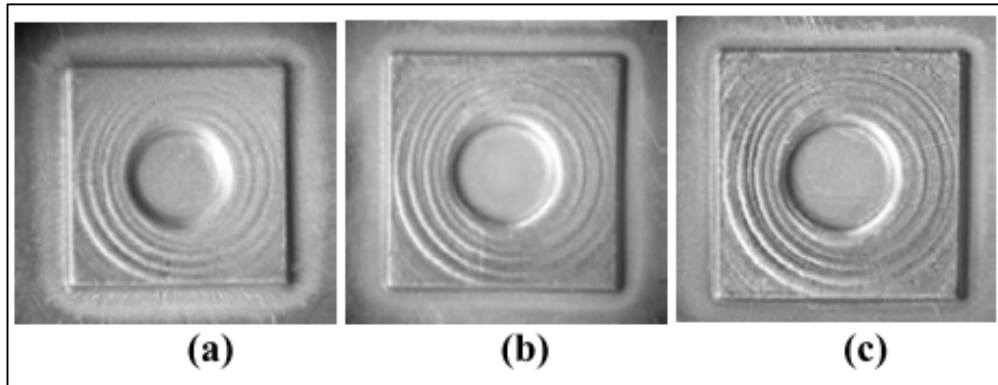

Figure 14: Plots showing effect of electrolyte concentration on (a) MRR (b) Machining speed and side gap. Adapted from references [21][23].

## 2.5 Interelectrode gap

In micro-ECM process, size of inter-electrode gap, its control and monitoring plays an important role in influencing machining resolution, machining precision, workpiece surface quality, tool design and machining efficiency. The aspect of inter-electrode gap in micro-ECM is related to several other parameters such as moving precision of cathode, gap voltage, electrode polarization in the gap, electrolyte parameters (composition, concentration, pressure, temperature) [53]. In order to achieve faster and localized material removal, a lower value (5 – 100  $\mu\text{m}$ ) of inter-electrode gap is found suitable for machining accuracy [40], [160]. In micro-ECM, the inter-electrode gap is modelled as a RC circuit as covered earlier in Section 2.1 and Figure 4(b). In a recent study [161], it was observed that the double layer capacitance and charging constant depend highly on the inter-electrode gap and by using smaller machining gaps, sub-micrometer precision can be realized. Figure 15 shows the improvement in micromachining accuracy on using lower IEG in micro-ECM [40]. However, it is not an easy task to achieve lower inter-electrode gaps. Furthermore, lower IEG may affect process stability due to change in electrolyte flow and mass transport conditions [6]. When the IEG is too low, flushing becomes difficult and may cause even electrolyte boiling. This can severely affect the accuracy of machining. Furthermore, when the feed rate of the tool electrode is higher than the frontal material removal rate, short circuiting takes place. This affects the process adversely. Therefore, an optimum value of IEG should be maintained. This necessitates the understanding of IEG in micro-ECM and also the maximum current flowing through IEG should be controlled. The parameters which affect the inter-electrode gap in pulse micro-ECM drilling are voltage, pulse on time, tool feed rate and duty cycle [162]. As mentioned in the work of Bilgi et al. [162], the interaction of these parameters affect the frontal material removal rate, electrolyte conductivity and changes in current flow which in turn cause variations in inter-electrode gap during drilling. Several gap control and monitoring strategies such as adaptive control and fuzzy logic based gap control [41], short circuit detection [50], current monitoring [50]–[52], force sensing [53], use of ultrasonics [54] and machine vision [55], intelligent process models [56], etc. have been proposed in literature. Bubble evolution [163]–[166] and sludge generation are the major phenomenon which makes it difficult to use smaller IEGs in micro-ECM. In case of stationary electrolyte and gap sizes of 30 and 100  $\mu\text{m}$ , the gap is filed with bubbles within 8 ms and 16 ms respectively [163]. This reduces the machining current with time. Flushing of electrolyte is found to be beneficial as it flushes out the bubble before they coalesce. Figure 16 shows the gas bubble evolution and bubble clustering on cathode during pulsed micro-ECM for gap voltage of greater than 1 V [164]. By using a conical tool and dedicated experimental arrangement, it was observed that gap voltage is the major influencing parameter which governs bubble propagation speed, bubble size and bubble coalesce [165].



**Figure 15:** Effect of IEG on dimensional accuracy keeping other factors same. A micromachined cavity at (a) IEG 50  $\mu\text{m}$  (b) IEG 15  $\mu\text{m}$  (c) IEG 5  $\mu\text{m}$ . Adapted from Ref [40].

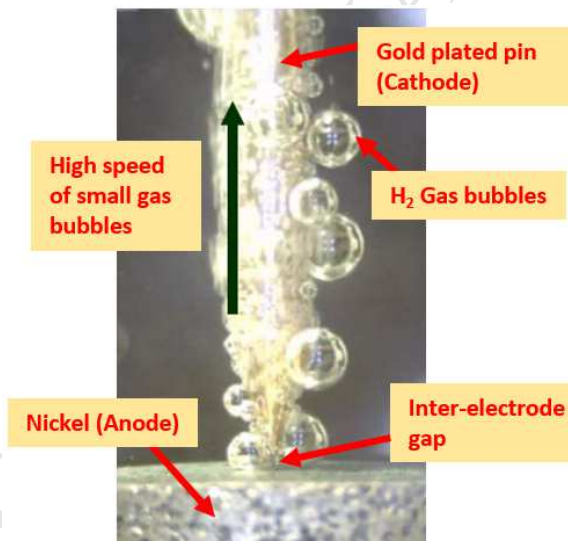
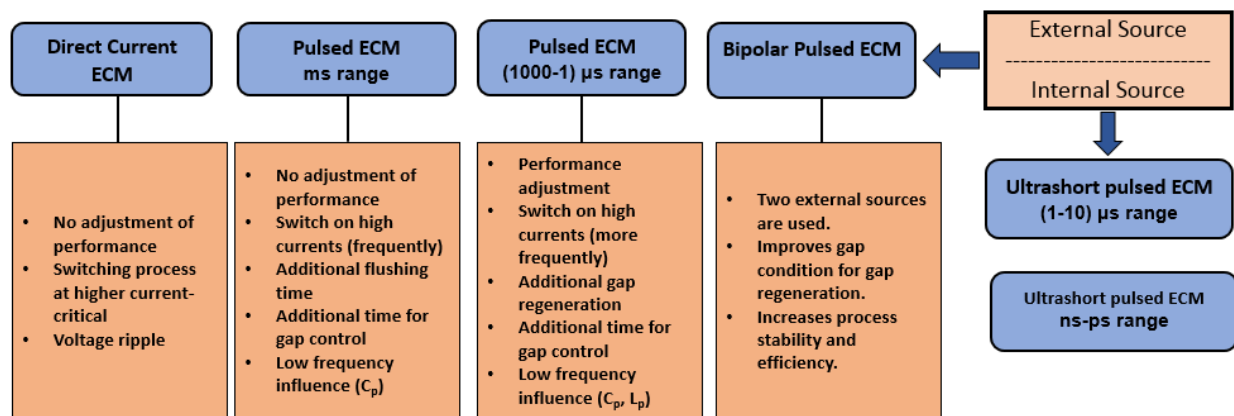

**Figure 16:** Gas bubble evolution in the inter-electrode gap and clustering of bubbles on cathode during pulsed electrochemical micromachining for gap voltage  $\sim 1.9$  V. Adapted from Ref [164].

## 2.6 Process energy source

The conventional ECM with direct current as a process energy source suffers from the aggressive and stray material removal, formation of oxide layer, passive film and cavitation. In

order to minimize these problems, pulse electrochemical machining (PECM) was introduced [5] [167]. Figure 17 gives a broad classification of process energy sources for electrochemical micromachining [168]. In PECM, the current is supplied in the form of pulses. The power switch unit is the main element which is used to create the pulse. The parameters pulse on-time and duty factor can be used to control the process. It has been observed that pulse parameters affect the machining gap, machining time, accuracy and surface roughness significantly during electrochemical machining [6], [23], [44]. Furthermore, during pulse off time the tool retracts back thereby providing good electrolyte flow. Also, during pulse off time tool repositioning and gap monitoring can also be done. Although some literatures report fabrication of micro-dimensional features and shapes using pulsed ECM with ms and  $\mu$ s pulses but the machining accuracy is rather low due to higher machining gap. To achieve high accuracy and highly localized material removal, the phenomenon of double layer reloading is utilized which requires nano-second pulses [38] [169]. Figure 18 shows a block diagram of major elements of a nano-second pulsed power supply [170]. The ns pulsed power supply consist mainly of PIC single chip computer, MAX038 pulse generator, complementary chopper circuit, DC voltage-stabilizing circuit, sampling circuit and fast protection circuit. The complementary chopper circuit avoids waveform distortion and facilitates in achieving higher pulse frequency. The short circuit



protection helps in avoiding damage to electrical components in case of short circuit between electrodes during micro-ECM.

Figure 17: Classification of process energy sources for electrochemical machining. Redrawn from Ref [168]

The major limitations on development of nanosecond pulsed power sources for micro-ECM are due to the technological limitation on maximum switching frequency (1 MHz) of conventional MOSFETs [171] and the effect of stray inductance and capacitance [168]. The stray capacitance delays the rise time of current pulses and also causes a significant overshoot at the end of pulse which is not desirable in ideal micro-ECM process. Furthermore, the parasitic inductance of connecting cables increases the rise time of current pulses especially for ultrashort pulses. The delayed attainment of peak current reduces productivity [168]. Figure 19 shows the effect of parasitic inductance on the current pulse during micro-ECM. It is worthwhile to note that pulse rise time increases with an increase in parasitic inductance value. For inductance of

50nH, the pulse rise time is shortest. To minimize the effect of parasitic cable inductance, the cable length should be minimized and the process energy source should be located close to the machining head [57], [171], [172].

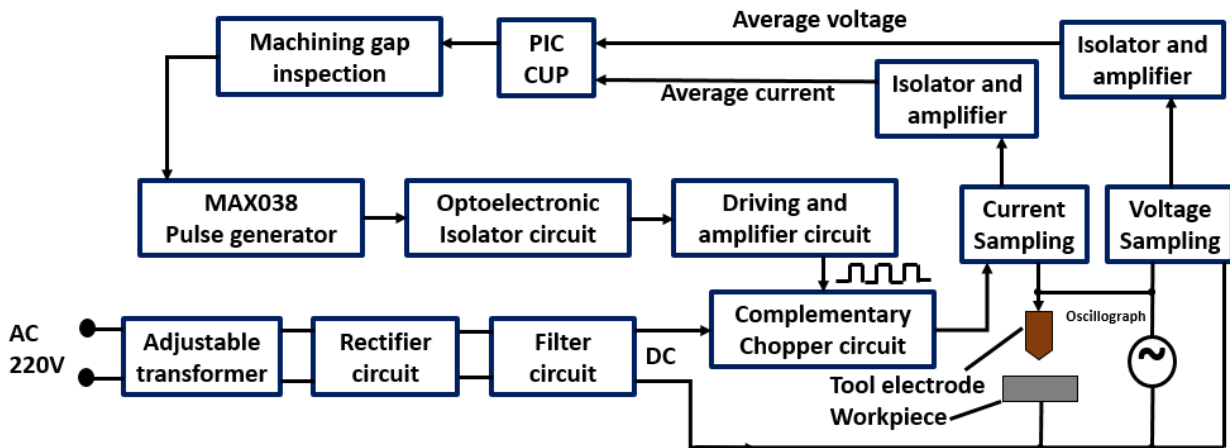

Figure 18: Block diagram of a pulsed power supply for electrochemical micromachining. Redrawn from Ref [170].

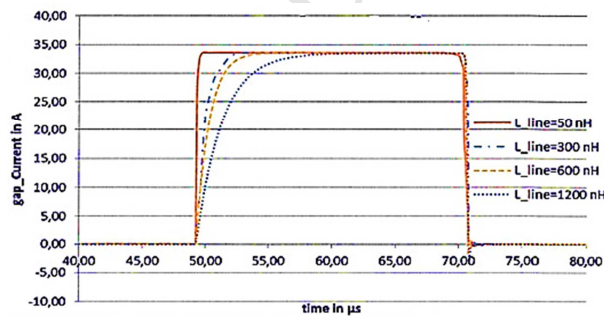

Figure 19: Effect of parasitic inductance on the current pulse in electrochemical micromachining. Adapted from ref [168].

The high frequency pulsed power sources for micro-ECM are still in research and development stage. Table 9 compiles the published works on development of ultrashort pulsed power supplies along with their main characteristics. Among the notable works, Spieser et al. [171] designed and developed a power supply unit for micro-ECM that had the capability to drill deep holes. The power supply unit has capability of providing pulses with a frequency ranging from 2 kHz to 8 MHz. It was also able to reverse pulse polarity and add a positive/negative biases during pulse off-time. The pulse power supply unit was also equipped with an ultra-fast

(50-ns time delay) short-circuit protection. Zhang et al. [170] developed a nanosecond pulse power supply for micro-ECM with minimum pulse on time of 50 ns. They also employed a chopper circuit to prevent waveform distortion. Experiments on micro-ECM drilling were performed and it was observed that high frequency, short pulse width power supply helps to achieve better surface quality and higher machining accuracy. It has also been proposed that low level voltage based pulse current supply improves electrochemical machining accuracy and reduces tool wear [173]. In the work of Schulze et al. [172], two variants of pulse power units for pulse-ECM and pulse micro-ECM were developed for stable micro-ECM process parameter settings and accurate capturing of gap current which is essential in micro-ECM process. Above all from the literatures on process energy sources for micro-ECM, it can be inferred that in the design of process energy sources, the primary aim should be to minimize the losses due to stray capacitances, inductances and even resistances in the current path so as to obtain less power loss, less voltage drop and steep rise of current pulses.

**Table 9: Reported works on development of power sources for electrochemical micromachining and their main characteristics.**

Reference	Main characteristics
[171]	<ul style="list-style-type: none"> <li>• Overcurrent protection incorporated.</li> <li>• Quick communication protocol between power supply and motion controller.</li> <li>• Current max 10A, Frequency: 2kHz-8MHz, Voltage max 15 V, Smallest pulse duration: 50 ns.</li> </ul>
[173]	<ul style="list-style-type: none"> <li>• Low level voltage improves machining accuracy.</li> <li>• Optimal low level voltage conditions depend on pulse duty ratio.</li> </ul>
[170]	<ul style="list-style-type: none"> <li>• Nanosecond pulse power supply with minimum pulse duration 50 ns.</li> <li>• Complementary chopper circuit to prevent waveform distortion.</li> <li>• Fast short circuit protection – response time &lt; 5<math>\mu</math>s.</li> </ul>
[57]	<ul style="list-style-type: none"> <li>• Use of Gallium nitride based transistors as a novel switching technology</li> <li>• Modulated frequency of up to 45MHz with a minimum pulse on time of 14ns.</li> <li>• A novel multi-probe IEG connection concept- can transmit pulses to IEG with inductance of 50nH and 50 ns pulses.</li> </ul>
[172]	<ul style="list-style-type: none"> <li>• Use of bipolar pulse unit for loading and unloading the double layer capacitances.</li> <li>• Highlighted the problems with inductances in gap circuit.</li> <li>• Provision for gap current sensing.</li> </ul>
[174]	<ul style="list-style-type: none"> <li>• Use of ultrashort current pulses ~ 100 ns for accuracy improvement.</li> <li>• Accurate measurement of average voltage gap and short circuit detection.</li> </ul>

- Convenient tuning of pulse duration, frequency and peak current.

## 2.7 Tooling aspects

It is well known that in electrochemical machining process, the tool shape is copied into workpiece surface [4], [9], [149]. The copying accuracy and efficiency of micro-ECM processes also depends on the tooling aspects. Whether it is micro drilling or micro milling or free form machining, the tooling aspect plays a major role. In the past few years, researchers have come up with several standard and customized tool designs for improving the process performance of micro-ECM. Table 10 gives a compilation of different tool designs proposed for improvement in process performance along with necessary details. Several aspects are cross connected and common with macro-ECM and features on tools can be scaled down to make them applicable in micro-ECM also. The subsequent subsections deal with tooling aspects of micro-ECM in brief. A discussion is also presented on side insulation coatings on the tools in high aspect ratio machining using micro-ECM for preventing lateral dissolution.

**Table 10: Difference types of tool-electrode configurations investigated in electrochemical micromachining technology as compiled from different references..**

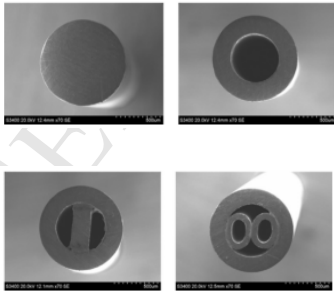
Electrode configuration	Electrode	Electrode material used in reference	Purpose solved
Multi-hole electrodes [175]		Brass	To prevent formation of residual cylinder in blind hole drilling

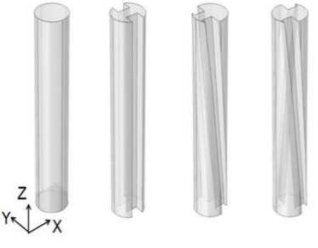
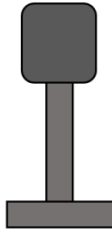
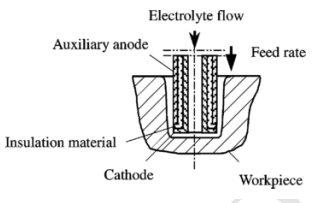
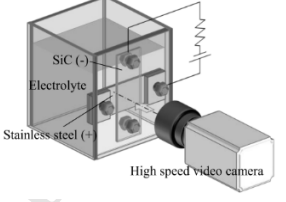
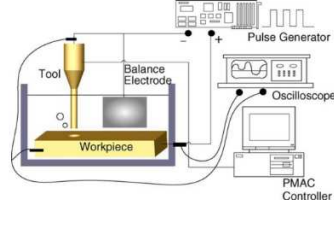

Grooved electrodes [176]		-	For improved flushing of debris and machining byproducts for deep hole drilling
Disc electrode [98]		-	To fabricate micro-holes with internal grooves.
Dual Pole Tool [177]		Outer bush is an auxiliary anode made of insoluble metal and inner one is pipe like cathode tool with epoxy resin layer between them.	To prevent stray machining and improve machining accuracy.
Transparent electrode [163]		SiC single crystal semiconductor	Observation of ECM gap phenomenon
Balance electrode [96]		Platinum	For the compensation of the difference of voltage drops between electrolyte and two electrodes. Prevent passive layer formation.

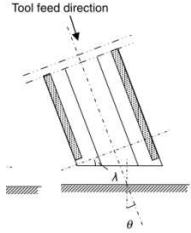
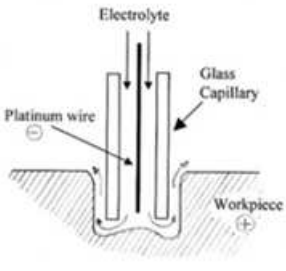
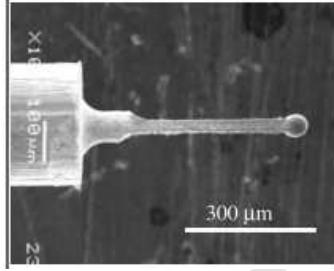
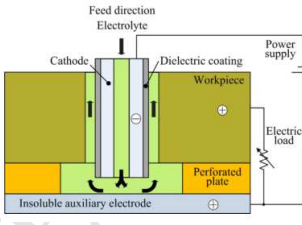
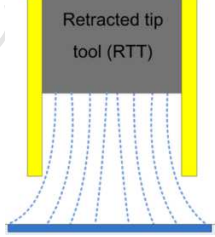
Wedge shape electrode [178]		Metal	To drill inclined holes with large inclination angles.
Capillary electrode [8]		Glass capillary with Pt wire as cathode	Glass capillary can bend for angular adjustments. Drilling holes in production components with positioning and diametric tolerances of G0.05 mm.
Spherical electrode [33], [179]		Tungsten	To achieve micro-holes/cavities with less degree of taper.
Insoluble auxiliary electrode [180]		Platinum	To improve dimensional accuracy on the exit side of hole
Retracted tip tool [181]		Tungsten with Silica coating	To confine the electric field distribution to the electrode region and improve machining accuracy.

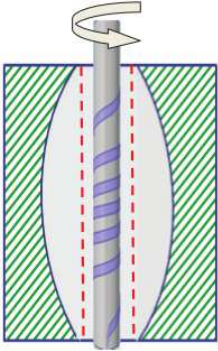
Tool with controlled conductivity [182]		Non-conductive rod wrapped with conductive wire	To control the internal shape of micro-holes.
-----------------------------------------	-----------------------------------------------------------------------------------	-------------------------------------------------	-----------------------------------------------

### *Tool material*

For micro-ECM, a tool material should possess high electrical and thermal conductivity, stiff enough to withstand high pressure electrolyte and good corrosion resistance [35]. The suitable candidate materials for ECM tool electrode are platinum [130][132], brass [92][75], titanium [77], tungsten [131][135][136][101], stainless steel [84][110][79], molybdenum and copper [25][83][11][72]. The conductive plastic tube [183] and glass capillaries (with Pt wire) [184][8] have also been tested as a candidate tool material. The selection of tool material mainly depends on the electrochemical properties required for material removal and are specific to the workpiece to be drilled. Tables 4-6 report the tool materials used for machining specific material.

### *Tool shape and structure*

A good tool design for micro-ECM drilling should accommodate space for electrolyte flow [178]. Ahn et al. [96] conducted research on using electrodes with different bottom shape in electrochemical micro drilling. It was mentioned that the bottom shape of the tool electrode affect the machinability and quality of micro hole. When a flat bottomed electrode is employed (Fig. 20(a)), the electrolyte supply is not sufficient and the workpiece beneath the central part of the tool is not well machined. On the other hand, a spherical bottomed electrode (Fig. 20(b)) exhibits better machinability due to improved electrolyte supply. This electrode design is more useful when micro-drilling of blind holes is required. In the work of Liu et al. [185], spherical, conical and flat tip electrodes were fabricated and used for electrochemical micromachining. It was concluded that conical tip electrode produces better results during drilling of micro holes, flat shaped electrode is recommended for fabrication of complex plane structures layer by layer and spherical ended electrodes produce micro-holes with less degree of taper. In order to reduce taper, spherical ended electrodes were fabricated and increase in dimensional accuracy was observed [33]. For deep hole drilling, tubular electrodes are preferred which can provide effective flushing at higher pressures at higher depths. However, internal flushing through a tubular electrode requires complex spindle design with isolation from corrosion (due to acidic electrolytes) and high current (required for micro-ECM drilling).

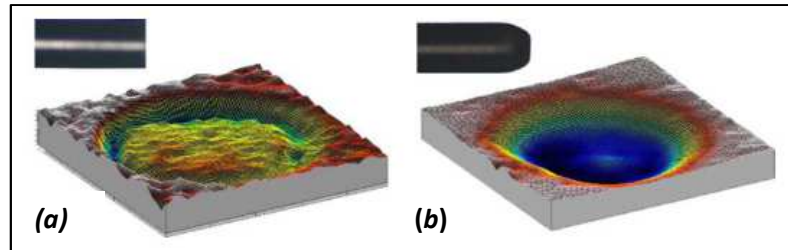

**Figure 20: (a) Machined surface when using flat-bottom electrode. (b) Machined surface with spherical-bottom electrode. [96]**

### *Tool size*

The diameter of the tool is determined according to the dimension of the feature to be machined. Furthermore, the limitation on minimum size is imposed by the requirement of sufficient strength of tool electrode to withstand electrolyte pressure and the lateral forces. For standard dimensions, the commercial tool electrodes are now already available in the market. For non-standard diameters or for custom electrode requirements, on machine wire dress units/block grinding [186] and electrochemical etching/machining [41], [49], [187] can be used to fabricate the electrodes. However, the repeatability of producing constant diameter electrodes using these methods is limited. To ensure process repeatability, on machine laser based measurement as well as touch method based measurement of electrode diameter is used.

The current density in micro-ECM process depends on the diameter of the tool and the level and shape of current pulse depends on tool electrode length. Park et al. [35] studied the effects of tool electrode length and diameter on micro-ECM process characteristics as shown in Fig. 21 (a) and (b) respectively. It can be observed from Fig. 21(a) that the current level and rising time increase with an increase in tool length. This is due to the decrease in cell impedance because of the decrease in resistance and increase in capacitance. Furthermore, it is the effect of increase in inductance with increase in tool length which affects the rising time of current. Figure 21(b) shows that as the diameter of tool electrode increases, there is a decrease in cell impedance and this results in an increase in rising time of double layer potential. Therefore, there is no sufficient rise in potential within the short pulse duration. As a result, machining rate decreases with an increase in tool diameter for same pulse on time [35]. However, the tool diameter selection is based mainly on the dimension of hole/feature/microstructure to be machined and the drilling strategy to be used (planetary or linear feed). Optimum machining conditions can be achieved by proper process parameter settings for a fixed tool diameter.

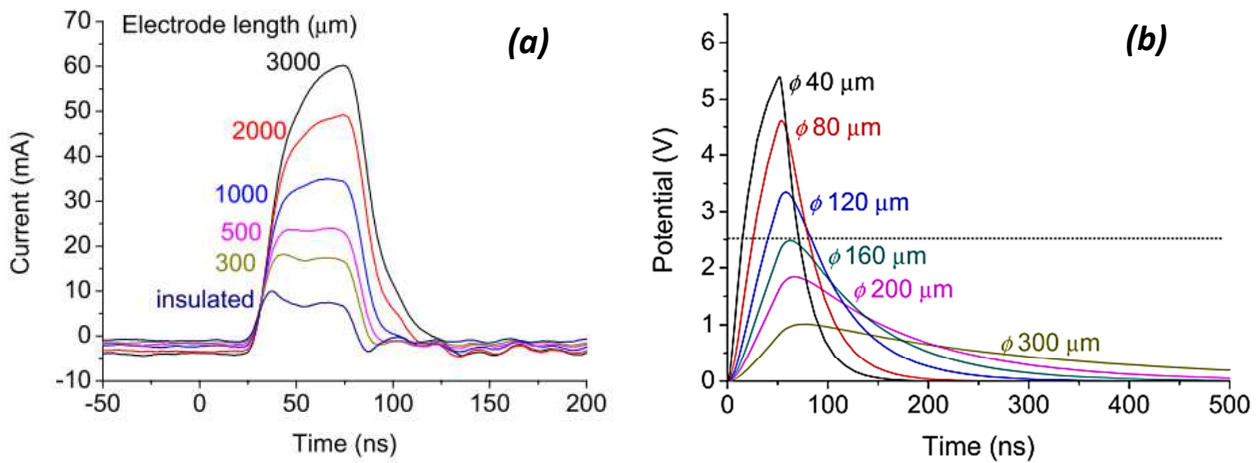

Figure 21: (a) Dependence of current shape on tool electrode length (tool diameter:  $70\ \mu\text{m}$ , pulse:  $6\ \text{V}$ ,  $50\ \text{ns}/1\ \mu\text{s}$ ). (b) Double layer potentials according to tool electrode diameter (pulse:  $6\ \text{V}$ ,  $50\ \text{ns}/1\ \mu\text{s}$ ). Adapted from ref [35].

#### Side insulation coatings for micro-ECM tools

During high aspect ratio machining using micro-ECM, there is usually an overcut and tapered profile of hole. This is due to the stray dissolution in the lateral gap. To prevent the material removal on the lateral sides of the tool, the tool electrodes are coated with insulation coatings on the sideways. Selection of tool coating material is crucial for the stability of micro drilling process. The coating material should possess high temperature stability, durability, strong adhesion to tool material, ability to be coated with uniform thickness and resistance to chemical corrosion. Researchers have investigated Parylene [188] [189], double layer of epoxy resin [190], SiCN-SiC [189], diamond like carbon [191], double insulation layer of  $\text{TiO}_2$  and organic film [192], silica layer [36], nickel [193][194] for coating the sides of tool and have reported less taper, enhanced dimensional accuracy of the machined holes. Table 11 shows the major reported works on use of insulated tools. The coatings on tool suffer from delamination during drilling process. The control of insulation thickness is a major issue. The insulation thickness should be less than the size of machining gap. Furthermore, delamination of coatings and deposition of drops during coating process is also observed which can deteriorate process accuracy [189].

Table 11: Reported works on use of side insulation coatings on micro-ECM tools for improved dimensional accuracy and reduction in hole taper.

Tool material	Coating	Coating method	Main findings	Reference
---------------	---------	----------------	---------------	-----------

Tungsten	Parylene	Vapor deposition polymerization in vacuum	Reduction in hole taper was observed.	[188]
Nickel	WSR-618 epoxy resin	Spin coating	Good electrical insulation, good adhesive strength, Operating life of 6 hours under simulated micro-ECM conditions.	[190]
-	704 Silica film	Spin coating	Reduction in stray corrosion, cavities with vertical sidewalls can be effectively machined.	[36]
316 Stainless Steel	Diamond like carbon, epoxy resin and Teflon	-	The durability of coating depends on the adhesion strength between coating and cathode. Diamond like carbon coatings are most durable in micro-ECM.	[191]
Tungsten	Nickel	Electrodeposition	Ni coated tungsten micro tool has higher electrochemical stability, higher durability and good corrosion resistance.	[193]
Titanium	Double insulating layer of TiO <sub>2</sub> ceramic coating and organic film	Combination of micro arc oxidation (MAO) and electrophoresis	Double insulating layers have good insulation strength and good durability. Precise holes can be machined.	[192]

### 3. ECM based hybrid micromachining technologies

The advent of novel materials together with trend of product miniaturization has necessitated research into hybrid micromachining technologies. As per the definition proposed by CIRP committee, “The hybrid machining processes are based on the simultaneous and controlled interaction of machining mechanisms and/or energy sources/tools having a significant effect on the process performance” [195], [196]. The word ‘simultaneous and controlled interaction’ means that the two or more process energies should interact in the same processing zones and at the same time. Based on this definition, the hybrid machining processes have been classified into assisted and combined processes. Therefore in this review paper, same basis have been used to classify the electrochemical micromachining based hybrid processes into assisted and combined electrochemical micromachining processes. Figure 22 gives a broad classification of electrochemical micromachining based hybrid processes. In ECMM based assisted processes (Figure 22), the primary process participating in material removal is micro-ECM and the other

processes assist the micro-ECM process in several aspects such as removal of passivating layer, effective electrolyte flushing, localization of material removal, machining of novel materials, etc. However, in ECMM based combined processes (Figure 26), both micro-ECM and the other process participate in material removal. The resulting synergetic effect is a  $1+1 = 3$  effect [195] which implies that the combined effect of micro-ECM with other process energy is more than double the benefits of individual process energies. This is because the two process energies react with the workpiece and also react with each other.

The major objectives of hybridizing electrochemical micromachining with other process energies are listed below:

- Broaden the material processing window of existing electrochemical micromachining process. For e.g. machining of novel materials such as shape memory alloys, additively manufactured alloys, non-conductive materials [197]–[203].
- Improve the localization of material removal of electrochemical micromachining to achieve high dimensional accuracy and satisfy tight dimensional tolerances [78], [204], [205].
- Improving the electrolyte flushing in machining zone to facilitate evacuation of machining by-products [154], [186], [206], [207].
- Removal of passivating layer of electrochemical micromachining [78], [133], [208][209].
- Combine two contrary machining objectives: high MRR with high surface finish [78], [204], [205].
- Machining of complex shapes at micrometer scale.
- Reducing the heat induced defects of other micromachining technologies based on thermal principle of material removal such as micro-EDM, laser micromachining, etc. [203], [204], [210]–[214]

For successful hybridization of micro-ECM with other process energies and realize it in machining, several technological requirements have to be met and are listed below:

- Development of Universal machine tool capable of combining electrochemical micromachining with two or more processes [205], [208], [215].
- Synchronization of micro-ECM process energy with other process energies such as laser, micro-milling, micro-EDM by parametric optimization.
- Better understanding of material removal mechanisms under the simultaneous action of two or more process energies.
- Development of effective monitoring techniques that can monitor micro-ECM process together with other process energies.

Table 12 gives a technological overview of different types of electrochemical micromachining based hybrid processes. Different types of electrochemical machining based hybrid process are discussed in detail in subsequent sections.

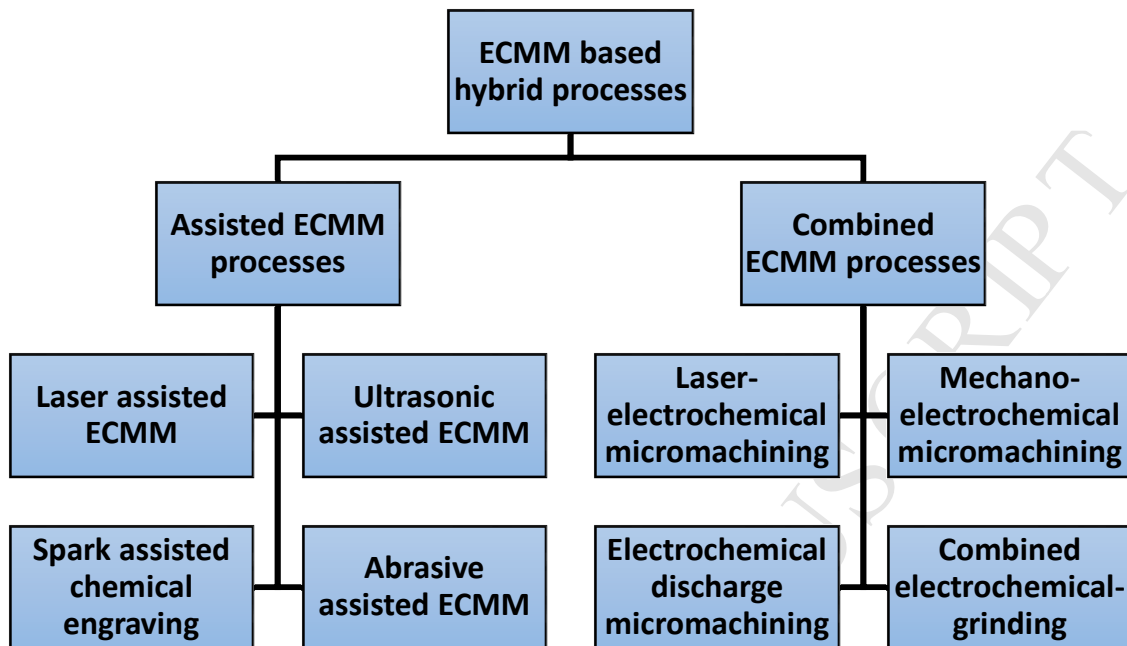

*Figure 22: Broad classification of electrochemical micromachining based hybrid processes.*

### 3.1 Assisted electrochemical micromachining processes

This section gives an overview of assisted electrochemical micromachining process. Figure 23 depicts the sketch of different types of assisted electrochemical micromachining processes.



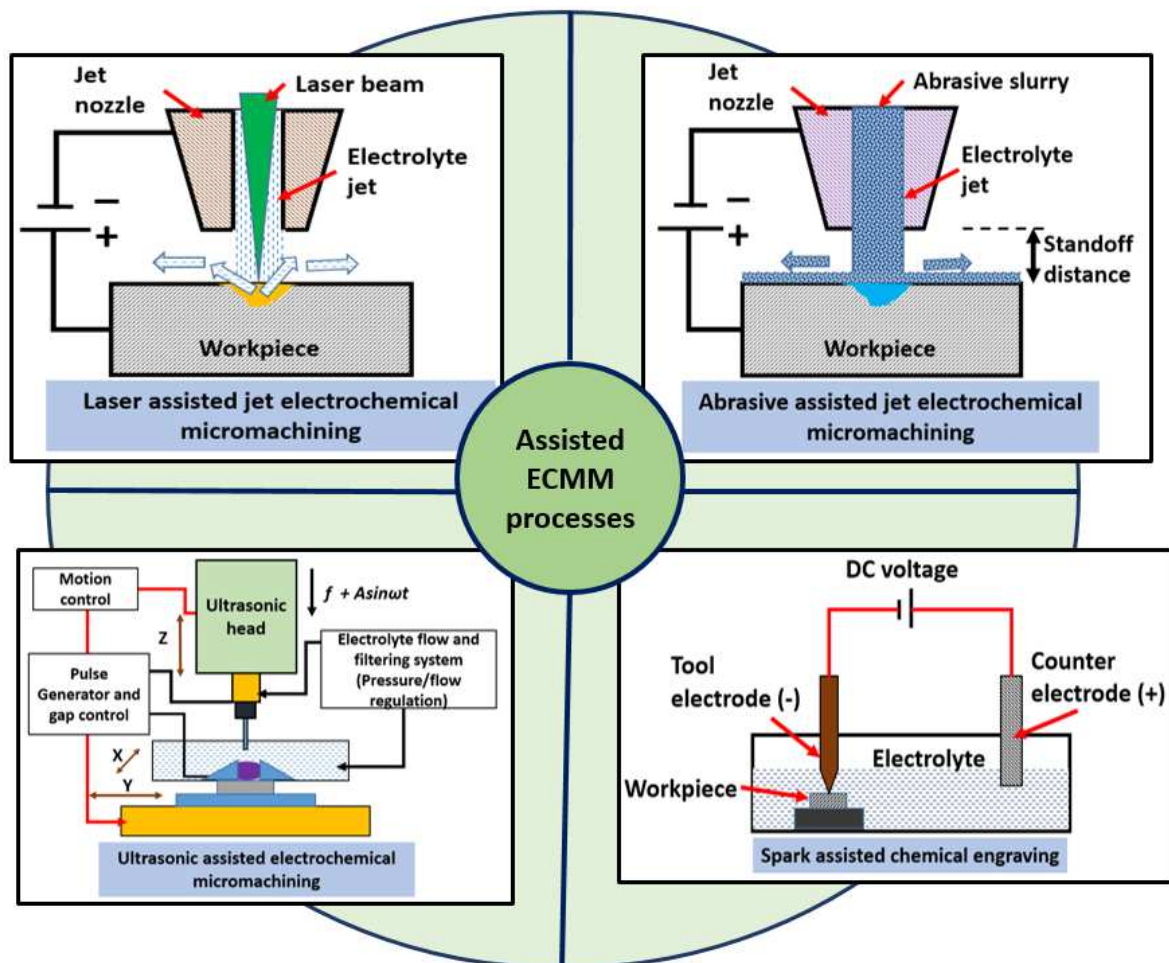

Figure 23: Overview of electrochemical micromachining based assisted processes.

#### (a) Laser assisted electrochemical micromachining (LAECM)

In Laser Assisted Jet-Electrochemical Machining (LAJECM) (Figure 23), a focused laser beam is used coaxially with electrolyte jet for better machining precision by localization of material removal [216]. The low power laser beam (average power 375 mW) causes the thermal activation of the outer layer of workpiece surface and the electrolytic jet causes anodic dissolution leading to faster material removal (Figure 24(a)[217]). Furthermore, the localized heat generated from laser beam accelerates the electrochemical reactions thereby achieving higher material removal rates. Mathematically, the different process energies can be represented as [218]:

The electrolyte jet energy ( $E_j$ ) is the main process energy responsible for dissolution of workpiece and can be written as:

$$E_1 = \int_0^{\tau_n} U^2 \frac{\kappa(t)A(t)}{g(t)} dt \quad (14)$$

Where,  $U$ : voltage,  $\kappa$  : conductivity,  $A$ : specific machining area,  $g$ : inter-electrode gap,  $t$ : machining time,  $\tau_n$ : end-time of machining.

The laser beam is basically a source of heat energy with Gaussian distribution ( $E_2$ ) and can be written as:

$$E_2 = \int_0^{\tau_n} P_i f \exp(-kr^2) t dt \quad (15)$$

Where,  $P_i$  : impulse laser power,  $f$  : laser pulse frequency,  $t$  : time,  $k$  : concentration factor,  $r$  : laser spot radius,  $\tau_n$  : end-time of machining.

The heat generated by laser increases the temperature of workpiece surface and reduces the activation energy (Eq. 16). This increases the current density and accelerates the electrochemical reactions.

$$J = \kappa_a \cdot C_R \exp\left(-\frac{E_a}{RT}\right) \quad (16)$$

where,  $J$ : current density,  $\kappa_a$ : anode process constant,  $C_R$ : reducing concentration constant,  $E_a$ : activation energy.

It has been observed that the temperature in the laser localized zone was 1.75-3.25 times higher than the temperature outside the laser localized area and the temperature increase varies inversely with the thermal conductivity of the material (Figure 24(b)[217]). The combination of laser beam with electrolytic jet causes higher material removal in axial direction as compared to lateral direction and thus high aspect ratios and dimensional precision is achieved. Pulsed lasers of ultra-short duration are found to reduce problems of electrolyte boiling. For hybrid laser-electrochemical micromachining technologies, green lasers (532 nm) are preferred because of their very low absorption coefficient ( $0.045 \text{ m}^{-1}$ ) for water as compared to infrared lasers. The laser beam also facilitates removal of passivating layer from the workpiece and thus it is suitable for machining titanium alloys, steels [218] and superalloys. The laser assisted ECM has the potential for fabrication of micro-dimensional features as it depends on size of jet. According to the results of Pajak et al. [216], laser assisted jet electrochemical machining improves volumetric material rate of 20, 25, 33 and 54 % for Hastelloy®, titanium alloy, stainless steel and aluminum respectively. Stephen et al. [197] proposed laser assisted chemical etching where a low power laser beam (2, 16 W) was used to accelerate chemical etching process using  $\text{H}_3\text{PO}_4$  as etchant. The laser beam supports mainly the kinetics of dissolution without any melting effects. The technology has been demonstrated to fabricate clean surfaces on nitinol, electron beam apertures and round rotary swaging tools.

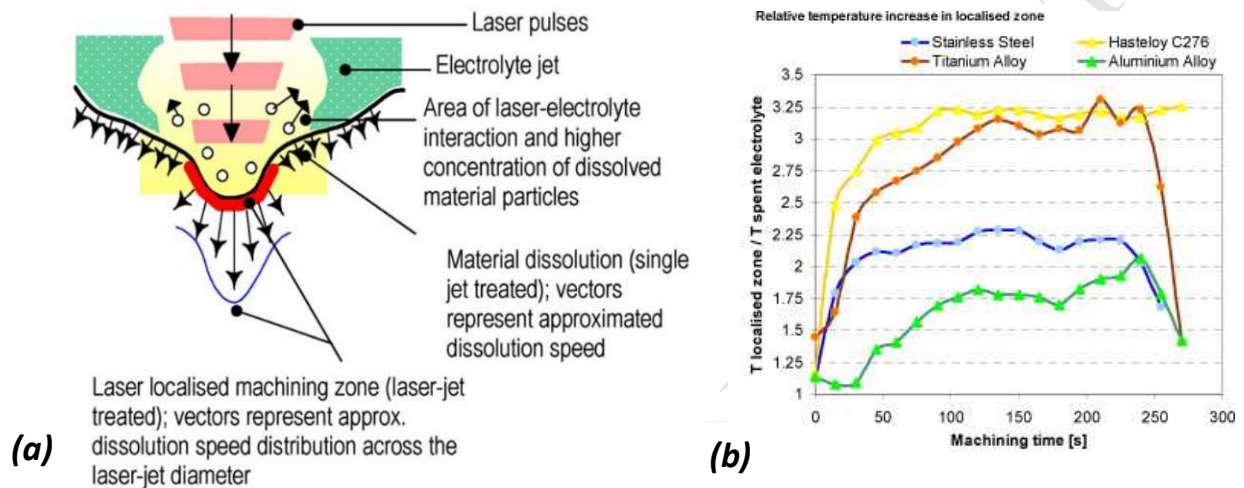

**Figure 24:** (a) Laser localized machining are in laser assisted electrochemical machining. (b) Plot showing temperature in the laser localized zone relative to temperature of spent electrolyte with machining time ( $U$ : 140 V, Initial IEG: 2mm,  $C_p$ : 10%,  $v$ : 5.8 m/s, Temperature in non-localized area 25-30 deg C). Adapted from ref [217].

### (b) Ultrasonic assisted electrochemical micromachining (UAECM)

The objective of using ultrasonic assistance in electrochemical micromachining is multi-fold. The ultrasonic vibrations facilitate removal of reaction byproducts and heat from machining zone, favors diffusion, minimizes passivation, creates optimal hydrodynamic conditions, improves aspect ratios and influences electrolytic reactions through sonochemical reactions [207][186][206]. Literatures report imparting ultrasonic vibrations to tool electrode [207], workpiece [206][133] and even electrolyte [154] with similar objectives. Figure 23 shows the sketch of ultrasonic assisted micro-ECM drilling setup where the tool electrode is subjected to ultrasonic vibrations [207]. Literatures report ultrasonic frequencies of 28kHz [206], 40kHz [186], 20kHz [207] and 1.7 MHz [154] depending on the process configuration and method of actuation.

One of the important phenomenon in UAECM is transient cavitation and microbubble generation. The ultrasonic vibration leads to the cavitation micro-bubbles near the surface of the tool and workpiece electrodes and the gap conditions favor their growth. The collapse of microbubbles in a very short time generates high temperature and pressures which are favorable for mass and charge diffusion in the machining gap. Thus, the electrolyte flow and electrochemical reactions are benefited [207]. Yang et al. [186] studied the effect of ultrasonic

vibrations on micro-ECM process using a fluid micro cell. The ultrasonic wave travelling in Z direction can be represented as a longitudinal wave as in Eq. 17[186].

$$P = \rho g(h + z) + \omega A c \rho \cos \omega \left( t - \frac{z}{c} \right) + P_0 \quad (17)$$

where,  $P$ : pressure variation with  $z$ ,  $P_0$ : pressure acting on the boundary surface between the electrolyte and air,  $\rho$ : density of the electrolyte,  $g$ : acceleration due to gravity,  $\omega$ : ultrasonic frequency,  $c$ : speed of wave,  $t$ : time,  $A$ : wave amplitude,  $h$ : height of electrode immersed in electrolyte. The maximum or minimum pressure can be obtained by partial differentiation of Eq. 17 with respect to frequency.

$$\frac{\partial P}{\partial \omega} = A c \rho \left\{ \cos \omega \left( t - \frac{z}{c} \right) - \omega \left( t - \frac{z}{c} \right) \sin \omega \left( t - \frac{z}{c} \right) \right\} \quad (18)$$

From Eq. 18, applying the condition of maxima-minima, it can be deduced that maximum and minimum pressure occurs at points which satisfy Eq. 19.

$$\tan \omega \left( t - \frac{z}{c} \right) = \left\{ \omega \left( t - \frac{z}{c} \right) \right\}^{-1} \quad (19)$$

From Eq. 18 and 19, it can be inferred that the maximum pressure at a given point ( $z$ ) increases with the ultrasonic frequency. Hence, ultrasonic vibrations are responsible for frequent and larger pressure increases in the machining gap and this leads to enhanced electrolyte diffusion and elimination of bubble. Figure 25 shows the comparison of machining time of electrochemical machining with and without ultrasonic assistance at same feed rate of  $0.1 \mu\text{m/s}$  [186]. It can be observed that machining time reduces by 87% by using ultrasonic assistance in micro-ECM due to improvement in electrolyte diffusion in the gap. Besides the process parameters (current density, voltage, pulse parameters and electrolyte concentration) involved in electrochemical micromachining, the amplitude of ultrasonic vibration plays an important role. Low amplitudes don't give additional benefits. Too high amplitudes affect machining precision especially while machining micro-dimensional features. There exists an optimal amplitude which favors electrolyte diffusion and removal of byproducts from machining zone without compromising on machining precision [206]. The optimal amplitude depends on several factors i.e. machine configuration, method of actuation and technological specifications of transducer, dimensions of feature to be machined, required aspect ratios, etc.

**Figure 25: Plot of drilling process with and without ultrasonic vibrations in micro-ECM. Adapted from ref [186].**

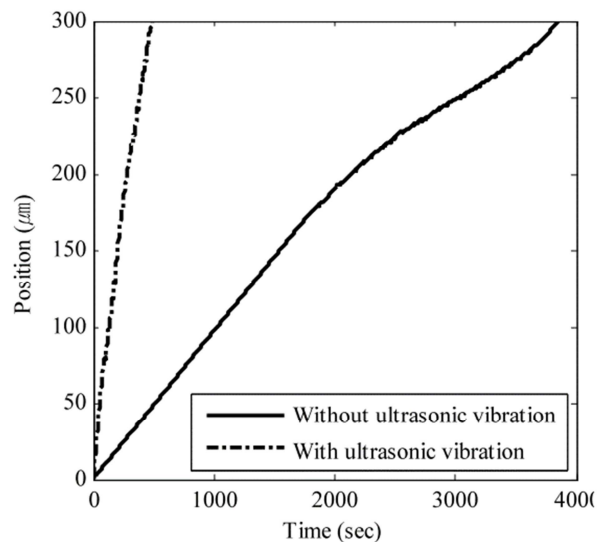

**(c) Abrasive assisted electrochemical micromachining (AAECM)**

In abrasive assisted electrochemical micromachining, abrasives are used to facilitate material removal by electrochemical micromachining. One such example is electrochemical slurry jet machining (sketch in Figure 23). The abrasive ( $\text{Al}_2\text{O}_3$ ) slurry in the electrolyte (NaCl) facilitates removal of passivating layer by impact action on the workpiece [219]. This process is particularly suitable for machining of WC which undergoes excessive corrosion and passivation under jet –ECM. The working voltages range from 60-120 V. The material removal rate and aspect ratios are affected by total abrasive kinetic energy, voltage and concentration of electrolyte [219]. In another configuration, abrasive assistance with wire-ECM improves the surface quality and material removal rate during slicing of silicon for photovoltaic applications [201]. The mechanical action facilitates removal of passivating layer on silicon along with reduced kerf loss.

**3.2 Combined electrochemical micromachining processes**

This section gives an overview of combined electrochemical micromachining processes as depicted in Figure 26. Figure 26 depicts the sketch of different types of combined electrochemical micromachining processes where both process energies participate in material removal in the same machining zone.

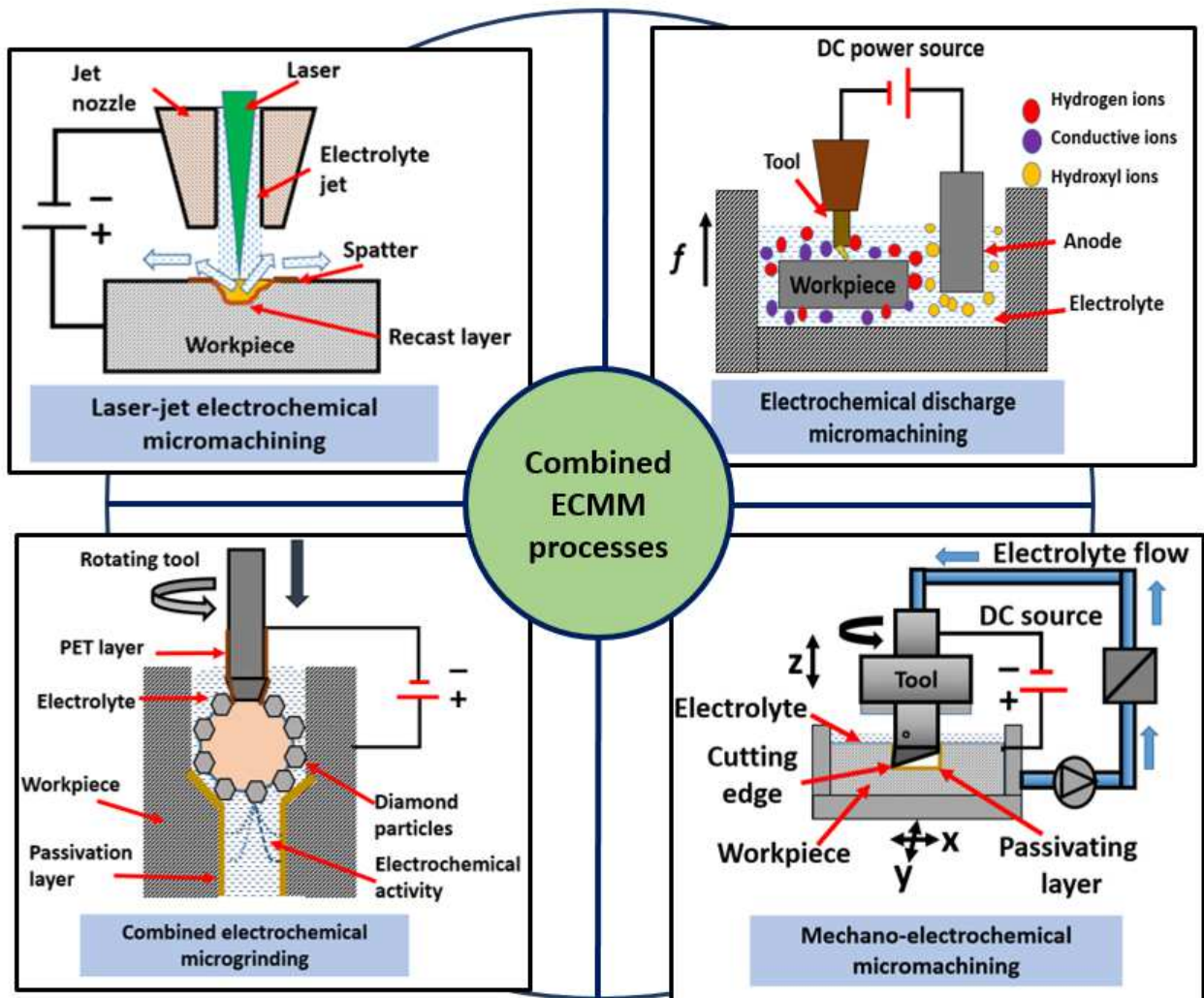
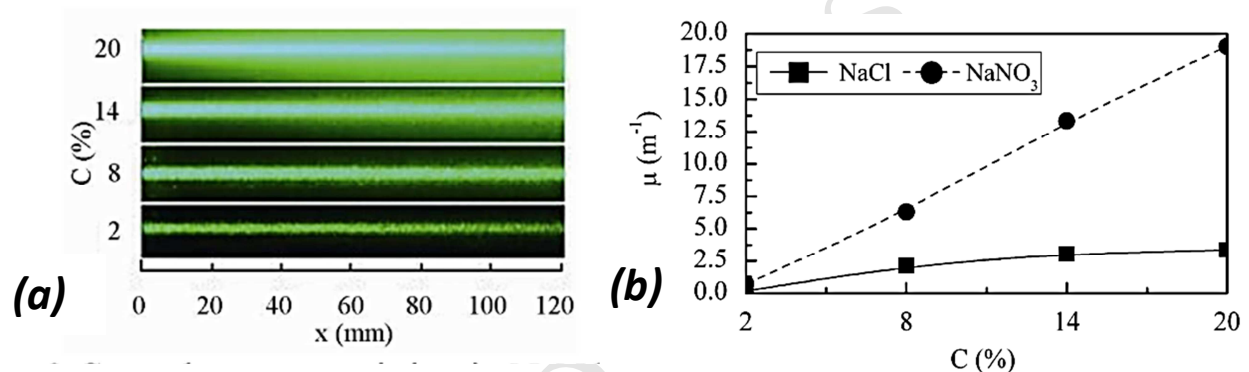

Figure 26: Overview of electrochemical micromachining based combined processes.

#### (a) Laser-electrochemical micromachining (LECM)

In laser-electrochemical machining, the laser beam also participates in material removal in addition to electrochemical process energy. Thus there are two process energies participating in material removal i.e. energy of photons (laser) and energy of ions (electrochemical). This is different from the laser assisted electrochemical micromachining in section 3.1, where laser only increases the temperature to enhance kinetics of electrochemical reactions. Figure 26 shows the sketch of laser-electrochemical micromachining. The process makes use of high power pulsed lasers aligned coaxially with electrolyte jet [204], [220] or guided into electrolyte jet [210]. The selection of laser power and pulse energies depend on the ablation thresholds of the materials to

be machined. In this configuration, laser attenuation by electrolyte is a major concern. Researchers [204] have observed that green laser ( $\lambda = 532$  nm) is transparent for water based electrolytes and it doesn't go absorption based attenuation in water. However, green laser faces attenuation by virtue of scattering from salt particles and it can be controlled by the concentration of electrolyte. This can be visualized from Figure 27(a) where the green laser beam becomes brighter with an increase in ( $\text{NaNO}_3$ ) salt concentration in electrolyte [220]. It can be observed from Figure 27(b) that the attenuation coefficient for green laser increase almost linearly with an increase in salt concentration [204]. The attenuation coefficients for scattering is higher for aq.  $\text{NaNO}_3$  electrolyte as compared to aq.  $\text{NaCl}$  electrolyte. On the other hand, infrared lasers undergo attenuation through absorption in water and are not recommended to complement material removal of micro-ECM. The process produces very clean surfaces with reduced or no heat affected zone, recast layer and spatter[210].

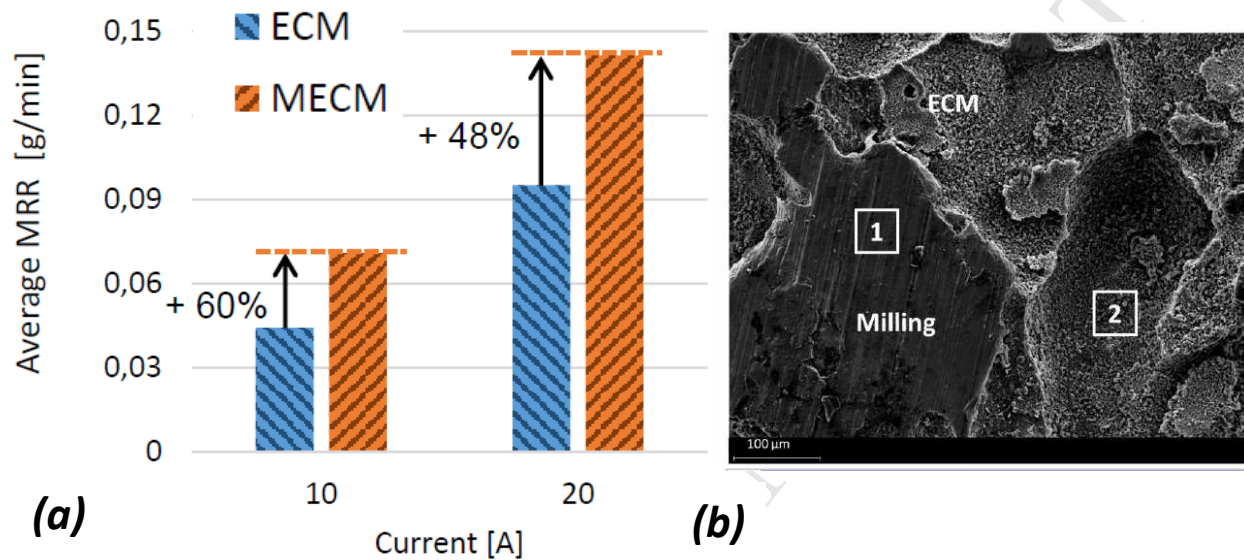

**Figure 27: (a) Light path of green laser in sodium nitrate electrolyte. The scattering (brightness) of laser beam increases with an increase in electrolytic concentration. (b) Attenuation coefficient for green laser vs concentration for electrolyte. Adapted from ref [204].**

### **(b) Mechano-electrochemical milling (MECM)**

The mechano-electrochemical milling (MECM) is under development with an objective to machine difficult to cut materials such as Titanium with improved productivity and better surface quality. Figure 26 shows a sketch of hybrid mechano-electrochemical setup. The critical aspect in this hybrid technology is the design of a tool which is compatible with both milling and electrochemical machining. This is accomplished by using a cutting edge in the ECM tool [221]. Since, the cutting edge is always in contact with workpiece surface, it should be made of a material with very low electrical conductivity so as to avoid short-circuits which are not favorable for ECM process. As shown in Figure 28(a), higher MRR values are reported with MECM as compared to ECM at all levels of current. The other parameters were: electrolyte flow rate: 50l/h, tool feed rate: 25 mm/min, tool rotation: 1000 RPM, electrolyte: 200g/l aq.  $\text{NaNO}_3$ . However, it can be seen that at 10 A the MRR increase is by 60% which is higher than at 20 A (48 %). Figure 28(b) shows the characteristics of Titanium surface machined by MECM. The

two zones can be distinguished clearly. Zone 1 corresponds to mechanical cutting action by cutting edge whereas Zone 2 represents ECMed surface [221]. The cutting edge is primarily responsible for removal of passivating layer during electrochemical machining of Titanium.



**Figure 28:** (a) Comparison of average material removal for electrochemical and mechano-electrochemical milling processes. (b) SEM image of a surface located centrally in a slot machined by mechano-electrochemical milling. Adapted from ref [221].

### (c) Electrochemical discharge micromachining (ECDM)

In electrochemical discharge machining (ECDM) process, the capabilities of micro-ECM and micro-EDM processes are combined with each other to expand the processing window to non-conducting materials as well as to fabricate deep micro-holes, micro-channels, etc. [203], [205], [222]–[225]. It satisfies definition of both assisted and combined hybrid machining process. The setup consists of two electrodes, tool as cathode and an auxiliary electrode (anode) and the workpiece is kept below the tool electrode. A pulsed DC current is supplied between cathode (tool) and anode. An optimum gap is maintained and electrolyte is passed through the gap. The ECDM process involves two major phenomenon: electrolysis leading to generation of gas bubbles and arc discharge due to breakdown of gas film. Figure 29(a) shows the representative current and voltage waveforms of the ECDM process [225]. It can be observed from the waveforms that ECM precedes EDM. The ignition delay of EDM is utilized in electrochemical dissolution of workpiece. The important aspect of ECDM process is the gas film generated from ECM process as this gas film behaves as a dielectric for subsequent EDM process and its thickness is critical for process [226]. This phenomenon can be visualized from Figure 29(b) which was demonstrated with a dedicated setup [224]. The hybrid ECDM process offers dual advantage of higher removal rates of micro-EDM and good surface finish of micro-ECM,



thereby improving the machining performance. Zhang et al. [205] used tubular electrode concept for ECDM process and achieved both high MRR ( $\sim 110 \mu\text{m/s}$ ) and good finish in a low conductivity salt solution ( $0.1 - 10 \text{ mS/cm}$ ). It can be observed from Figure 29(c) that the speed of material removal of ECDM process is way higher than standalone ECM process and thus it is a promising hybrid process to speed up material removal of electrochemical machining [205].

The wettability of tool electrode affects micro-machining resolution [175], [227]. It has been observed that applied voltage is the influential parameter which influences MRR, ROC, HAZ thickness as compared to electrolyte concentration, tool immersion depth and inter-electrode gap in micro-ECDM drilling [228] [200]. Combination of rotational and axial movement of tool has also been tested to improve ECDM based micro drilling performance [229]. To remove the passive layer formation during ECDM, use of spring attachment in the tool has also been proposed [230]. The ECDM micromachining has been demonstrated on variety of non-conducting materials such as glass [231][232], pyrex wafer [233][234], alumina [235], quartz [236] and in trueing and dressing of metal bonded diamond grinding tools [225]. The major challenge in ECDM is design of an effective tool position control and process monitoring system. The development of ECDM micromachining technology depends on the development of suitable process energy sources [237] which satisfy the requirements of ECM, EDM and transition from ECM to EDM. In literatures, this machining technique is hailed through several names such as Electrochemical spark machining (ECSM), Electrochemical arc machining (ECAM) and even Spark assisted chemical engraving [238][239]. Readers are directed to references [222], [224] for detailed overview of ECDM based processes.

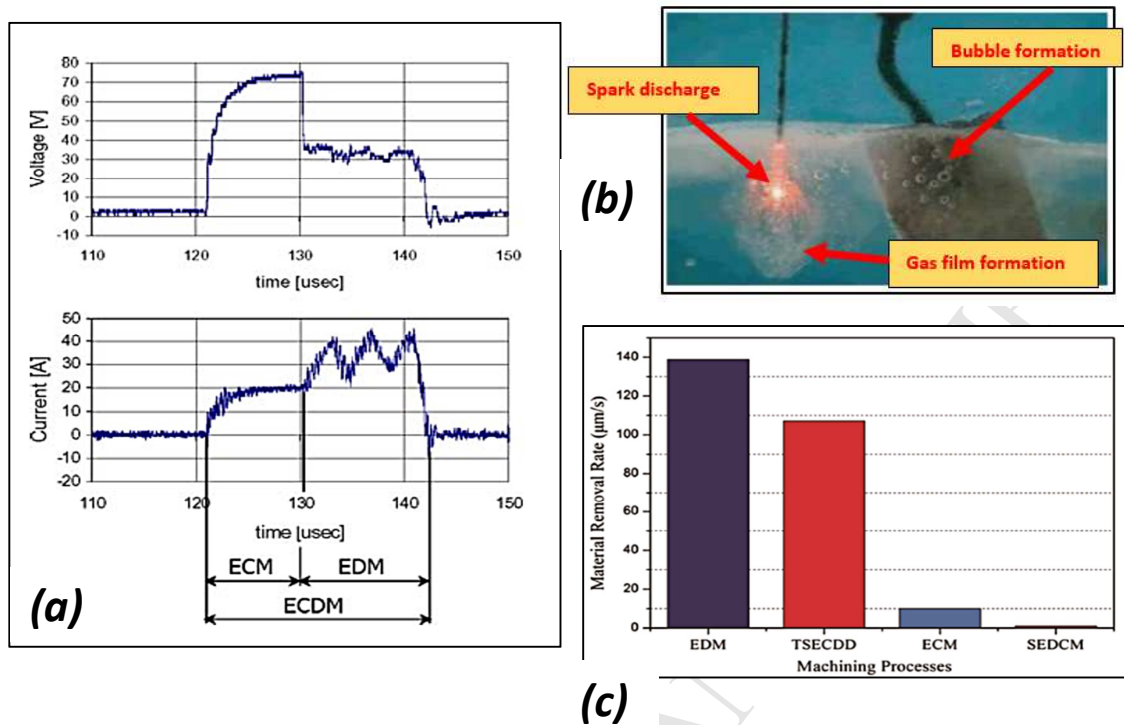

**Figure 29: (a) Current and voltage waveforms for electrochemical discharge machining [225]. (b) Demonstration of phenomenon of electrochemical discharge [224]. (c) Comparison of MRR in electrochemical discharge drilling with other competitive technologies [205].**

#### **(d) Combined electrochemical grinding for micromachining (CECG)**

In Combined electrochemical grinding (CECG) [78], [202], [240], the material removal is achieved by combined action of abrasive and electrochemical process energy. The rotating grinding wheel works as a cathodic tool [5]. The abrasive particles of the grinding wheel make a contact with the workpiece and the gap between the wheel and workpiece makes passage for electrolyte circulation. The gap voltages range from 2.5 to 14 V [78], [202], [240]. At the start of machining process, the material removal is achieved by the action of electrochemical process and this is followed by development of passivating layer on the workpiece surface. The abrasive grains participate in removal of passivating layer by cutting action and stabilize further dissolution by further exposing fresh workpiece surface [78]. In micromachining using combined abrasive and electrochemical action, the major percentage of material removal is due to electrochemical dissolution only. It has been reported that the pulse CECG exhibits offers better control of drilling process in comparison to conventional process which uses direct current. By using pulse power, the balance between electrochemical and mechanical removal can be adjusted by setting optimum pulse on-time and duty cycle. The tool rotation is an important parameter which governs the accuracy and surface quality in CECG based micromachining of micro-holes. Figure 30(a) shows the effect of tool RPM on the taper angle and surface roughness ( $R_a$ ) [78]. It can be observed that too low and too high RPMs are not good for the hybrid process. The reason is that at too low speeds, electrolyte flushing is not sufficient whereas too high speeds are not good for grinding due to increase in centrifugal forces. Figure 30(b) shows a micro-hole machined by CECG process at gap voltage of 4.5 V and feed rate of 6  $\mu\text{m/s}$ .

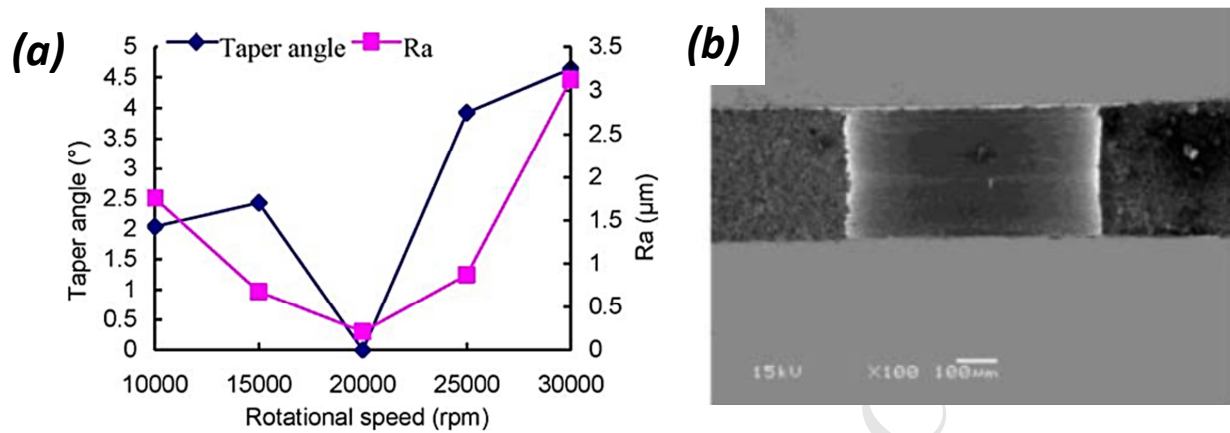

Figure 30: (a) Variation in surface roughness ( $R_a$ ) and taper angle with tool rotation speed during combined electrochemical and grinding. (b) Cross-sectional SEM image of a micro-hole fabricated by hybrid process of electrochemical removal and grinding ( $U$ : 4.5 V, feed rate: 6  $\mu\text{m/s}$ ). Adapted from ref [78].

Table 12: Technological overview of different types of electrochemical machining based hybrid processes.

ECMM based hybrid process	Process energies involved	Main process parameters	Advantages	Technological maturity
Laser assisted electrochemical micromachining [216], [218], [241], [242]	Laser, electrochemical	Laser average power, laser pulse energy, repetition rate, micro-ECM parameters	Improved reaction kinetics, localized material removal	Concept and Prototype development
Ultrasonic assisted electrochemical micromachining [133], [186], [206], [207], [243]	Ultrasonic vibration (mechanical) and electrochemical	Ultrasonic frequency and amplitude, tool design, micro-ECM parameters	Improved electrolytic diffusion, improved mass and charge transport, reduced passivation	Prototype development, Series production test
Abrasive assisted electrochemical micromachining [201], [219]	Abrasive impact (mechanical) and electrochemical	Concentration of slurry, abrasive particle size, speed, stand-off distance, micro-ECM parameters	Removal of passivating layer, stabilization of electrochemical dissolution	Prototype development
Laser-electrochemical micromachining [204], [210], [220]	Laser, electrochemical	Laser average power, laser wavelength, laser pulse energy, repetition rate, micro-ECM parameters	High MRR with good surface finish, reduced thermal defects of laser i.e. spatter, recast layer, HAZ	Concept and Prototype development
ECDM/SACE [223]–[225], [231]	Electrochemical and arc discharge	Gap voltage, gas film thickness, pulse duration, electrolyte type, concentration,	Machining of non-conductive materials, high MRR and good surface finish	Series production test

		conductivity and flow rate, tool material		
Combined electrochemical-grinding [78], [202], [240], [244]	Electrochemical, abrasive cutting (mechanical)	Grinding wheel type (grit size, bond type), wheel RPM, micro-ECM parameters	Removal of passivating layer, stabilization of electrochemical dissolution, improved MRR	Series production test
Mechano-electrochemical machining [221]	Electrochemical and mechanical (cutting edge)	Cutting edge radius, RPM, tool feed rate, micro-ECM parameters	Removal of passivating layer, high MRR	Fundamental research, concept development
*Micro-ECM parameters represents gap voltage, current density, pulse duration, duty cycle, tool feed rate, electrolyte type, pressure and concentration.				

## Future research directions

Apart from conventional sinking ECM and STEM processes, the research on micro-ECM focuses primarily on achieving localized and controlled material removal so as to improve dimensional accuracy, shape accuracy and simplification of tooling. Most of the literatures on micro-ECM report on fundamental understanding of electrochemical dissolution at micron scale and solutions to localize material removal, machinability evaluation of different materials, evaluation of process capabilities, effect of process parameters, development of improved tools, electrolyte selection and development of ultrashort pulsed power supplies. From the technological point of view, very few have addressed development of machine tools for practical application of micro-ECM technology. Even there are rarely commercial ECM machines which satisfy the technological requirements for micro-ECM. A lot of research is needed in developing compact, cost effective and reliable ultrashort pulsed power supplies. Furthermore, very few literatures correlate micro-ECM pulses with machining performance which is necessary for in-process monitoring. To avoid submerging of workpiece in electrolyte, several electrolyte confinement techniques need to be developed. Very few literatures have investigated possibility of using ecofriendly electrolytes which is needed for wide commercial acceptance of this technology. Due to the corrosive nature of process, in process metrology using sensors is difficult to apply. Innovative solutions are needed in this area. Although some literatures have visualized machining gap through dedicated setups, there is still lack of complete understanding of phenomenon occurring in inter-electrode gap during micro-ECM. This requires multidisciplinary knowledge and specialized demonstrator setups. Process modelling of micro-ECM is still under development and requires extensive efforts from manufacturing engineers, chemical engineers, physicists and chemists owing to its interdisciplinary nature. Machinability of novel materials like shape memory alloys, cermets, additively manufactured materials, sandwich materials, semiconductors, etc. using micro-ECM is still not studied comprehensively. Dissolution mechanisms of tool materials such as WC-Co with different Co percentage and SiC based ceramics need further research investigations with different electrolyte and parameter combinations. To broaden the material processing window of existing micro-ECM process and to improve machining performance both in terms of productivity and quality, extensive research

is needed into development of hybrid micro-ECM technologies. This requires development of multifunctional machine tools that are compatible with two different process energies. Most of the hybrid micro-ECM processes are in concept development and prototype development stage and further research is needed to bring them into industrial applications. Material removal mechanisms under combined action of two or more process energies in same machining zone are not fully understood for different classes of materials. This is because when two process energies are hybridized, additional effects due to interaction come into picture. Another aspect which needs in-depth research is the synchronization of two different types of process energies so as to achieve dimensional and shape precision and achieve commercial acceptance.

## Conclusions

The review paper has presented updated state of the art and research developments in micro-ECM technology and its hybrid variants with regard to process fundamentals, process configurations, process-material interaction, tooling aspects, electrolyte, process energy sources as well as research developments of micro-ECM based hybrid micromachining technologies. Development of a novel process and improvement of existing process requires several cross-innovations and knowledge of processes with similar roots. Therefore, this review paper fills the gap of a single extended literature source covering wide spectrum of knowledge of micro-ECM process and related hybrid process variants, thereby targeting both academic and industrial audience. Specifically, following points are concluded:

- Micro-ECM is considered to be a promising technology for micromachining. Some of the advantages are: (a) Absence of thermal defects such as HAZ, recast layer, spatter as compared to other competitive technologies such as laser micromachining and micro-EDM (b) Capability to fabricate complex micro-shapes using dedicated micro-tools (c) High surface finish can be obtained as dissolution occurs at atomic level (d) The precision of material removal can be controlled by using ultrashort pulsed power sources and suitable electrolytes (e) No process forces and tool wear involved (f) possibility to machine novel materials like shape memory alloys, additively manufactured materials (g) Micro-ECM can be conveniently hybridized with other processes to extend process capabilities and broaden material processing window.
- Most of the studies are based on fundamental aspects, machinability evaluation of different materials, evaluation of process capability, development of pulsed power supplies and parametric studies to evaluate process performance. Some aspects are still not fully established and require further research: (i) Development of dedicated machine tools (ii) Correlation of micro-ECM pulses with material removal (iii) Characterization of interelectrode phenomenon through dedicated setups (iv) Multidisciplinary modelling considering mass and charge transport, bubble phenomenon together with basic model of micro-ECM process (v) Evaluation of process and product fingerprint for micro-ECM process (vi) Alternatives for acidic electrolytes and development of ecofriendly electrolytes (vii) Development of electrolyte confinement techniques.

- Another important observation from the review is that micro-ECM based hybrid micromachining technologies offer promising capabilities such as: (i) Broadening of existing material processing window to novel materials and non-conductive materials (ii) Combination of two contrary objectives such as high MRR and high surface finish (iii) Assisting the existing micro-ECM process. The micro-ECM based hybrid processes are in concept and prototype development stage and have vast research space to be investigated. Some of the key aspects which are not yet fully covered in literatures are: (i) Design and development of multifunctional or Universal machine tools which have capability to be used with multiple process energies (ii) Understanding of material removal mechanisms on different materials when two or more process energies act simultaneously in same machining zone (iii) Synchronization of two process energies on same machining axis so as to control precision of material removal and shape control (iv) Improved understanding of interaction of two process energies with each other when they are on same machining axis.

## References

- [1] E. Uhlmann, B. Mullany, D. Biermann, K. P. Rajurkar, T. Hausotte, and E. Brinksmeier, "Process chains for high-precision components with micro-scale features," *CIRP Ann. - Manuf. Technol.*, vol. 65, no. 2, pp. 549–572, 2016.
- [2] H. N. Hansen, Y. Zhang, and A. Islam, "Tolerances in micro manufacturing," in *World Congress on Micro and Nano Manufacturing 2017, Kaohsiung, Taiwan.*, 2017.
- [3] T. Masuzawa, "State of the Art of Micromachining," *CIRP Ann. - Manuf. Technol.*, vol. 49, no. 2, pp. 473–488, 2000.
- [4] C. van Osenbruggen and C. De Regt, "Electrochemical micromachining," *Philips Tech. Rev.*, vol. 42, no. 1, pp. 22–32, 1985.
- [5] R. K.P., Z. D., M. J.A., K. J., and D. S. A., "New developments in electro-chemical machining," *CIRP Ann. - Manuf. Technol.*, vol. 48, no. 2, pp. 567–579, 1999.
- [6] B. Bhattacharyya, J. Munda, and M. Malapati, "Advancement in electrochemical micro-machining," *Int. J. Mach. Tools Manuf.*, vol. 44, no. 15, pp. 1577–1589, 2004.
- [7] D. Landolt, P. F. Chauvy, and O. Zinger, "Electrochemical micromachining, polishing and surface structuring of metals: Fundamental aspects and new developments," *Electrochim. Acta*, vol. 48, no. 20–22, pp. 3185–3201, 2003.
- [8] M. Sen and H. S. Shan, "A review of electrochemical macro- to micro-hole drilling processes," *Int. J. Mach. Tools Manuf.*, vol. 45, pp. 137–152, 2005.
- [9] K. P. Rajurkar, M. M. Sundaram, and A. P. Malshe, "Review of electrochemical and electrodischarge machining," *Procedia CIRP*, vol. 6, pp. 13–26, 2013.
- [10] R. J. Leese and A. Ivanov, "Electrochemical machining - review of factors affecting the process applicability in micro-manufacturing," *Proc. Inst. Mech. Eng. Part B J. Eng. Manuf.*, 2016.
- [11] D. S. Bilgi, V. K. Jain, R. Shekhar, and S. Mehrotra, "Electrochemical deep hole drilling in super alloy for turbine application," *J. Mater. Process. Technol.*, vol. 149, no. 1–3, pp. 445–452, 2004.
- [12] L. Yong and H. Ruiqin, "Micro electrochemical machining for tapered holes of fuel jet nozzles," *Procedia CIRP*, vol. 6, no. ISEM XVII, pp. 395–400, 2013.
- [13] A. B. Kamaraj, M. M. Sundaram, and R. Mathew, "Ultra high aspect ratio penetrating metal microelectrodes for biomedical applications," *Microsyst. Technol.*, vol. 19, no. 2, pp. 179–186, 2013.
- [14] J. Bannard, "The use of electrochemical machining in biomedical engineering," *J. Appl. Electrochem.*, vol. 5, no. 1, pp. 89–90, 1975.
- [15] "Indec TM: <http://www.indec-ecm.com/en/scope/medicine/>."
- [16] "HH Bosch GmbH: <http://www.bosch-hh.de/index.php?id=ecm>."
- [17] X. Lu and Y. Leng, "Electrochemical micromachining of titanium surfaces for biomedical applications," *J.*

- Mater. Process. Technol.*, vol. 169, no. 2, pp. 173–178, 2005.
- [18] M. Datta and L. T. Romankiw, "Application of chemical and electrochemical micromachining in the electronics industry," *J. Electrochem. Soc.*, vol. 136, no. 6, p. 285C–292C, 1989.
- [19] P. T. Pajak, R. Van Tijum, H. Altena, and C. R. Visser, "Virtual design of the shaving cap ECM process by multiphysics simulation approach," in *16th International Symposium on Electromachining, ISEM 2010*, 2010, pp. 693–697.
- [20] H. S. J. Altena, "EDM and ECM for mass production Philips DAP," *J. Mater. Process. Technol.*, vol. 149, no. 1–3, pp. 18–21, 2004.
- [21] B. Bhattacharyya and J. Munda, "Experimental investigation on the influence of electrochemical machining parameters on machining rate and accuracy in micromachining domain," *Int. J. Mach. Tools Manuf.*, vol. 43, no. 13, pp. 1301–1310, 2003.
- [22] B. H. Kim, S. H. Ryu, D. K. Choi, and C. N. Chu, "Micro electrochemical milling," *J. Micromechanics Microengineering*, vol. 15, no. 1, pp. 124–129, 2004.
- [23] T. Kurita, K. Chikamori, S. Kubota, and M. Hattori, "A study of three-dimensional shape machining with an ECμM system," *Int. J. Mach. Tools Manuf.*, vol. 46, no. 12–13, pp. 1311–1318, 2006.
- [24] S. S. Joshi and D. Marla, *Electrochemical Micromachining*, vol. 11. Elsevier, 2014.
- [25] S. Sharma, V. K. Jain, and R. Shekhar, "Electrochemical drilling of inconel superalloy with acidified sodium chloride electrolyte," *Int. J. Adv. Manuf. Technol.*, vol. 19, no. 7, pp. 492–500, 2002.
- [26] M. A. H. Mithu, G. Fantoni, and J. Ciampi, "The effect of high frequency and duty cycle in electrochemical microdrilling," *Int. J. Adv. Manuf. Technol.*, vol. 55, no. 9–12, pp. 921–933, 2011.
- [27] A. Spieser, "PhD Thesis: Development of an Electrochemical Micromachining (μECM) machine," Brunel University, London, 2015.
- [28] R. Schuster, V. Kirchner, P. Allongue, and G. Ertl, "Electrochemical micromachining," *Science (80-. )*, vol. 289, no. 5476, pp. 98–101, 2000.
- [29] Z. W. Fan, L. W. Hourng, and M. Y. Lin, "Experimental investigation on the influence of electrochemical micro-drilling by short pulsed voltage," *Int. J. Adv. Manuf. Technol.*, vol. 61, no. 9–12, pp. 957–966, 2012.
- [30] B. H. Kim, S. H. Ryu, D. K. Choi, and C. N. Chu, "Micro electrochemical milling," *J. Micromechanics Microengineering*, vol. 15, no. 1, pp. 124–129, 2004.
- [31] F. Klocke, S. Harst, L. Ehle, M. Zeis, and A. Klink, "Material Loadings during Electrochemical Machining (ECM) - A First Step for Process Signatures," *Key Eng. Mater.*, vol. 651–653, no. 1, pp. 695–700, 2015.
- [32] A. Klink, "Process Signatures of EDM and ECM Processes – Overview from Part Functionality and Surface Modification Point of View," *Procedia CIRP*, vol. 42, no. Isem Xviii, pp. 240–245, 2016.
- [33] H. S. Li, D. Meng, G. Q. Wang, and Y. Bin Zeng, "Electro-Chemical Micro Drilling by Micro-Spherical Electrode," *Adv. Mater. Res.*, vol. 1089, pp. 324–330, 2015.
- [34] L. Zhaolong, W. Dongbo, D. Shichun, L. Peng, and S. Shufa, "Research on Electrochemical Machining Small Holes in Variable Pressure Field Using Tubular Electrode (In Chinese)," *Electromachining Mould*, vol. 5, pp. 30–32, 2011.
- [35] B. J. Park, B. H. Kim, and C. N. Chu, "The effects of tool electrode size on characteristics of micro electrochemical machining," *CIRP Ann. - Manuf. Technol.*, vol. 55, no. 1, pp. 197–200, 2006.
- [36] M. H. Hu, Y. Li, Z. Yue, W. Jian, and X. G. Zhu, "Experimental Study of Micro Electrochemical Milling with Side-Insulated Electrode," *Appl. Mech. Mater.*, vol. 159, pp. 127–131, 2012.
- [37] V. Kirchner, X. Xia, and R. Schuster, "Electrochemical nanostructuring with ultrashort voltage pulses," *Acc. Chem. Res.*, vol. 34, no. 5, pp. 371–377, 2001.
- [38] M. Kock, V. Kirchner, and R. Schuster, "Electrochemical micromachining with ultrashort voltage pulses—a versatile method with lithographical precision," *Electrochim. Acta*, vol. 48, no. 20–22, pp. 3213–3219, 2003.
- [39] J. A. Kenney, G. S. Hwang, and W. Shin, "Two-dimensional computational model for electrochemical micromachining with ultrashort voltage pulses," *Appl. Phys. Lett.*, vol. 84, no. 19, pp. 3774–3776, 2004.
- [40] V. V. Lyubimov, V. M. Volgin, A. Y. Venetsev, and I. V. Gnidina, "Microelectrochemical Machining at the Ultrasmall Interelectrode Gaps with the Use of the Packets of Nanosecond Voltage Pulses," *Procedia CIRP*, vol. 42, no. Isem Xviii, pp. 831–836, 2016.
- [41] A. Spieser and A. Ivanov, "Design of an electrochemical micromachining machine," *Int. J. Adv. Manuf. Technol.*, vol. 78, pp. 737–752, 2015.

- [42] Z. W. Fan and L. W. Hourng, "Electrochemical micro-drilling of deep holes by rotational cathode tools," *Int. J. Adv. Manuf. Technol.*, vol. 52, no. 5–8, pp. 555–563, 2011.
- [43] Y. Liu and S. F. Huang, "Experimental study on electrochemical drilling of micro holes with high aspect ratio," *Adv. Mater. Res.*, vol. 941–944, pp. 1952–1955, 2014.
- [44] J. Kozak, K. P. Rajurkar, and Y. Makkar, "Selected problems of micro-electrochemical machining," *J. Mater. Process. Technol.*, vol. 149, no. 1–3, pp. 426–431, 2004.
- [45] G. Liu, Y. Li, Q. Kong, and H. Tong, "Research on ECM Process of Micro Holes with Internal Features," *Precis. Eng.*, 2016.
- [46] B. Ghoshal and B. Bhattacharyya, "Investigation on profile of microchannel generated by electrochemical micromachining," *J. Mater. Process. Technol.*, vol. 222, pp. 410–421, 2015.
- [47] C. Chen, J. Li, S. Zhan, Z. Yu, and W. Xu, "Study of Micro Groove Machining by Micro ECM," *Procedia CIRP*, vol. 42, pp. 418–422, 2016.
- [48] S. Hinduja and J. Pattavanitch, "Experimental and numerical investigations in electro-chemical milling," *CIRP J. Manuf. Sci. Technol.*, vol. 12, no. 2016, pp. 79–89, 2016.
- [49] Y. Liu, D. Zhu, and L. Zhu, "Micro electrochemical milling of complex structures by using in situ fabricated cylindrical electrode," *Int. J. Adv. Manuf. Technol.*, vol. 60, pp. 977–984, 2011.
- [50] L. Yong, Z. Yunfei, Y. Guang, and P. Liangqiang, "Localized electrochemical micromachining with gap control," *Sensors Actuators, A Phys.*, vol. 108, no. 1–3, pp. 144–148, 2003.
- [51] S. Harada and W. Natsu, "Study on Sensitivity of Gap-width Detection with Peak Current in Pulse ECM," in *Proceedings of the 12th euspen International Conference*, 2012, pp. 120–123.
- [52] W. Natsu and A. Terada, "Approach to Detect and Control Gap-Width with Peak Current in Pulse ECM," *Adv. Mater. Res.*, vol. 482–484, pp. 1973–1978, 2012.
- [53] Y. Lu, K. Liu, and D. Zhao, "Experimental investigation on monitoring interelectrode gap of ECM with six-axis force sensor," *Int. J. Adv. Manuf. Technol.*, vol. 55, no. 5–8, pp. 565–572, 2011.
- [54] D. Clifton, A. R. Mount, G. M. Alder, and D. Jardine, "Ultrasonic measurement of the inter-electrode gap in electrochemical machining," *Int. J. Mach. Tools Manuf.*, vol. 42, no. 11, pp. 1259–1267, 2002.
- [55] M. Kang, H. Kang, and X. Li, "Measurement of Electrochemical Machining Initial Gap Based on Machine Vision," *Adv. Mater. Res.*, vol. 230–232, pp. 1190–1194, 2011.
- [56] Y. Lu, M. Rajora, P. Zou, and S. Liang, "Physics-Embedded Machine Learning: Case Study with Electrochemical Micro-Machining," *Machines*, vol. 5, no. 1, p. 4, 2017.
- [57] T. Mole, B. McDonald, S. Mullery, C. Diver, and D. Tormey, "The Development of a Pulsed Power Supply for  $\mu$ ECM," *Procedia CIRP*, vol. 42, pp. 809–814, 2016.
- [58] M. A. H. Mithu, G. Fantoni, J. Ciampi, and M. Santochi, "On how tool geometry, applied frequency and machining parameters influence electrochemical microdrilling," *CIRP J. Manuf. Sci. Technol.*, vol. 5, no. 3, pp. 202–213, 2012.
- [59] W. Natsu, T. Ikeda, and M. Kunieda, "Study on Characteristics of High Speed Electrolyte Jet Machining," *Proc. 7th Int. Conf. Front. Des. Manuf.*, pp. 333–338, 2006.
- [60] M. Hackert-Oschaetzchen, G. Meichsner, M. Zinecker, A. Martin, and A. Schubert, "Micro machining with continuous electrolytic free jet," *Precis. Eng.*, vol. 36, no. 4, pp. 612–619, 2012.
- [61] J. Mitchell-Smith, A. Speidel, J. Gaskell, and A. T. Clare, "Energy distribution modulation by mechanical design for electrochemical jet processing techniques," *Int. J. Mach. Tools Manuf.*, vol. 122, no. May, pp. 32–46, 2017.
- [62] W. Natsu, T. Ikeda, and M. Kunieda, "Generating complicated surface with electrolyte jet machining," *Precis. Eng.*, vol. 31, no. 1, pp. 33–39, 2007.
- [63] M. Hackert-Oschaetzchen, R. Paul, A. Martin, G. Meichsner, N. Lehnert, and A. Schubert, "Study on the dynamic generation of the jet shape in jet electrochemical machining," *J. Mater. Process. Technol.*, vol. 223, pp. 240–251, 2015.
- [64] M. Hackert, G. Meichsner, and A. Schubert, "Generating Micro Geometries with Air Assisted Jet Electrochemical Machining," *Proc. 10th Anniv. Int. Conf. Eur. Soc. Precis. Eng. Nanotechnology, EUSPEN 2008*, vol. 2, no. May, pp. 420–424, 2008.
- [65] A. Schubert, M. Hackert-Oschätzchen, G. Meichsner, M. Zinecker, and J. Edelmann, "Precision and Micro ECM with Localized Anodic Dissolution," *Proceedings 8th Int. Conf. Ind. Tools Mater. Process. Technol.*, pp. 193–196, 2011.



- [66] M. Hackert-Oschätzchen, G. Meichsner, H. Zeidler, M. Zinecker, and A. Schubert, "Micro machining of different steels with closed electrolytic free jet," *AIP Conf. Proc.*, vol. 1353, pp. 1337–1343, 2011.
- [67] C. Guo, J. Qian, and D. Reynaerts, "Electrochemical Machining with Scanning Micro Electrochemical Flow Cell (SMEFC)," *J. Mater. Process. Technol.*, vol. 247, no. April, pp. 171–183, 2017.
- [68] C. Guo, J. Qian, and D. Reynaerts, "Fabrication of Mesoscale Channel by Scanning Micro Electrochemical Flow Cell (SMEFC)," *Micromachines*, vol. 8, no. 5, p. 143, 2017.
- [69] C. Guo, J. Qian, and D. Reynaerts, "Finishing of micro-EDMed surface based on scanning Micro electrochemical flow cell," *Procedia CIRP*, vol. 42, no. ISEM XVIII, pp. 837–841, 2016.
- [70] N. Qu, X. Fang, W. Li, Y. Zeng, and D. Zhu, "Wire electrochemical machining with axial electrolyte flushing for titanium alloy," *Chinese J. Aeronaut.*, vol. 26, no. 1, pp. 224–229, 2013.
- [71] D. Zhu, K. Wang, and N. S. Qu, "Micro wire electrochemical cutting by using in situ fabricated wire electrode," *CIRP Ann. - Manuf. Technol.*, vol. 56, no. 1, pp. 241–244, 2007.
- [72] B. Bhattacharyya, "Recent Advancements in EMM for Micro and Nanofabrication," *Electrochem. Micromach. Nanofabrication, MEMS Nanotechnol.*, pp. 219–240, 2015.
- [73] K. Xu, Y. Zeng, P. Li, and D. Zhu, "Study of surface roughness in wire electrochemical micro machining," *J. Mater. Process. Technol.*, vol. 222, pp. 103–109, 2015.
- [74] S. U. N. Jian-jun, L. I. Zhi-yong, and Z. Chuan-wu, "Electrochemical machining of film cooling holes in aeroengine (In Chinese)," *Electroplat. Finish.*, vol. 11, pp. 626–631, 2015.
- [75] Y. Zhang, Z. Xu, Y. Zhu, and D. Zhu, "Machining of a film-cooling hole in a single-crystal superalloy by high-speed electrochemical discharge drilling," *Chinese J. Aeronaut.*, vol. 29, no. 2, pp. 560–570, 2016.
- [76] M. Wang, D. Zhu, N. S. Qu, and C. Y. Zhang, "Preparation of Turbulated Cooling Hole for Gas Turbine Blade Using Electrochemical Machining," *Key Eng. Mater.*, vol. 329, pp. 699–704, 2007.
- [77] S. Ali, S. Hinduja, J. Atkinson, and M. Pandya, "Shaped tube electrochemical drilling of good quality holes," *CIRP Ann. - Manuf. Technol.*, vol. 58, no. 1, pp. 185–188, 2009.
- [78] D. Zhu, Y. B. Zeng, Z. Y. Xu, and X. Y. Zhang, "Precision machining of small holes by the hybrid process of electrochemical removal and grinding," *CIRP Ann. - Manuf. Technol.*, vol. 60, no. 1, pp. 247–250, 2011.
- [79] C. D. Zhou, E. J. Taylor, J. J. Sun, L. Gebhart, E. C. Stortz, and R. P. Renz, "Electrochemical machining of hard passive alloys with pulse reverse current," *Trans. NAMRI/SME*, vol. XXV, pp. 147–149, 1997.
- [80] S. H. Choi, B. H. Kim, H. S. Shin, D. K. Chung, and C. N. Chu, "Analysis of the electrochemical behaviors of WC-Co alloy for micro ECM," *J. Mater. Process. Technol.*, vol. 213, no. 4, pp. 621–630, 2013.
- [81] B. S. Arditti, S. J.; Avedikian, Souren Z.; Bernstein and P. H. Moss, "Method of electrochemically machining Titanium or Titanium alloy workpieces," *United States Patent-3,753,878*, pp. 3–4, 1971.
- [82] F. Klocke, M. Zeis, A. Klink, and D. Veselovac, "Experimental research on the electrochemical machining of modern titanium- and nickel-based alloys for aero engine components," *Procedia CIRP*, vol. 6, no. ISEM XVII, pp. 368–372, 2013.
- [83] Z. Y. Li, X. T. Wei, J. J. Sun, C. W. Zang, C. H. Fu, and Y. B. Guo, "Process capability and effect size of vacuum extraction shaped tube electrolytic drilling of Inconel alloy for high-performance cooling hole," *Int. J. Adv. Manuf. Technol.*, pp. 1–10, 2015.
- [84] J. Liu, D. Zhu, L. Zhao, and Z. Xu, "Experimental investigation on electrochemical machining of Y-TiAl intermetallic," *Procedia CIRP*, vol. 35, pp. 20–24, 2015.
- [85] A. A. Nayak, S. Gangopadhyay, and D. K. Sahoo, "Modelling, simulation and experimental investigation for generating 'l' shaped contour on Inconel 825 using electro chemical machining," *J. Manuf. Process.*, vol. 23, pp. 269–277, 2016.
- [86] A. Speidel, J. Mitchell-Smith, D. A. Walsh, M. Hirsch, and A. Clare, "Electrolyte jet machining of titanium alloys using novel electrolyte solutions," *Procedia CIRP*, vol. 42, no. ISEM XVIII, pp. 367–372, 2016.
- [87] B. Kersschot, J. Qian, and D. Reynaerts, "On the dressing behavior in ELID-grinding," *Procedia CIRP*, vol. 6, pp. 632–637, 2013.
- [88] S. P. Pavlinich, A. R. Mannapov, N. Z. Gimaev, and A. N. Zaitsev, "Electrochemical shaping of aerodynamic seal elements," *Russ. Aeronaut. (Iz VUZ)*, vol. 51, no. 3, pp. 330–338, 2008.
- [89] F. Klocke, A. Klink, D. Veselovac, D. K. Aspinwall, S. L. Soo, M. Schmidt, J. Schilp, G. Levy, and J. P. Kruth, "Turbomachinery component manufacture by application of electrochemical, electro-physical and photonic processes," *CIRP Ann. - Manuf. Technol.*, vol. 63, no. 2, pp. 703–726, 2014.
- [90] D. S. Patel, V. K. Jain, A. Shrivastava, and J. Ramkumar, "Electrochemical micro texturing on flat and curved

- surfaces: simulation and experiments," *Int. J. Adv. Manuf. Technol.*, 2016.
- [91] N. Holstein, W. Krauss, J. Konys, S. Heuer, and T. Weber, "Advanced Electrochemical Machining (ECM) for tungsten surface micro-structuring in blanket applications," *Fusion Eng. Des.*, pp. 1–5, 2016.
- [92] L. Tang, Z. J. Fan, G. G. Zhao, F. Yang, and S. Yang, "High aspect ratio deep spiral tube electrochemical machining technology," *Procedia CIRP*, vol. 42, no. Isem Xviii, pp. 407–411, 2016.
- [93] E. S. Lee, J. W. Park, and Y. H. Moon, "A Study on Electrochemical Micromachining for Fabrication of Microgrooves in an Air-Lubricated Hydrodynamic Bearing," *Int. J. Adv. Manuf. Technol.*, vol. 20, pp. 720–726, 2002.
- [94] P. S. Pa, "Yield enhancement for the surface of solar-cell silicon wafers with electromechanical micromachining," *Electrochim. Acta*, vol. 55, no. 10, pp. 3504–3510, 2010.
- [95] J. W. Byun, H. S. Shin, M. H. Kwon, B. H. Kim, and C. N. Chu, "Surface texturing by micro ECM for friction reduction," *Int. J. Precis. Eng. Manuf.*, vol. 11, no. 5, pp. 747–753, 2010.
- [96] S. H. Ahn, S. H. Ryu, D. K. Choi, and C. N. Chu, "Electro-chemical micro drilling using ultra short pulses," *Precis. Eng.*, vol. 28, no. 2, pp. 129–134, 2004.
- [97] M. Bassu, S. Surdo, L. M. Strambini, and G. Barillaro, "Electrochemical micromachining as an enabling technology for advanced silicon microstructuring," *Adv. Funct. Mater.*, vol. 22, no. 6, pp. 1222–1228, 2012.
- [98] C. H. Jo, B. H. Kim, and C. N. Chu, "Micro electrochemical machining for complex internal micro features," *CIRP Ann. - Manuf. Technol.*, vol. 58, no. 1, pp. 181–184, 2009.
- [99] M. Wang, W. Peng, C. Yao, and Q. Zhang, "Electrochemical machining of the spiral internal turbulator," *Int. J. Adv. Manuf. Technol.*, vol. 49, no. 9–12, pp. 969–973, 2010.
- [100] G. Liu, Y. Li, Q. Kong, and H. Tong, "Research on ECM process of micro holes with internal features," *Precis. Eng.*, vol. 47, pp. 508–515, 2017.
- [101] A. L. Trimmer, J. L. Hudson, M. Kock, and R. Schuster, "Single-step electrochemical machining of complex nanostructures with ultrashort voltage pulses," *Appl. Phys. Lett.*, vol. 82, no. 19, pp. 3327–3329, 2003.
- [102] B. H. Kim, C. W. Na, Y. S. Lee, D. K. Choi, and C. N. Chu, "Micro electrochemical machining of 3D micro structure using dilute sulfuric acid," *CIRP Ann. - Manuf. Technol.*, vol. 54, no. 1, pp. 191–194, 2005.
- [103] N. Holstein, W. Krauss, J. Konys, S. Heuer, and T. Weber, "Advanced Electrochemical Machining (ECM) for tungsten surface micro-structuring in blanket applications," *Fusion Eng. Des.*, vol. 109–111, pp. 956–960, 2015.
- [104] B. Bhattacharyya, M. Malapati, J. Munda, and A. Sarkar, "Influence of tool vibration on machining performance in electrochemical micro-machining of copper," *Int. J. Mach. Tools Manuf.*, vol. 47, pp. 335–342, 2007.
- [105] M. Burger, L. Koll, E. A. Werner, and A. Platz, "Electrochemical machining characteristics and resulting surface quality of the nickel-base single-crystalline material LEK94," *J. Manuf. Process.*, vol. 14, no. 1, pp. 62–70, 2012.
- [106] X. Ma, A. Bán, and R. Schuster, "Electrochemical machining of gold microstructures in LiCl/dimethyl sulfoxide," *ChemPhysChem*, vol. 11, no. 3, pp. 616–621, 2010.
- [107] X. Ma and R. Schuster, "Locally enhanced cathodoluminescence of electrochemically fabricated gold nanostructures," *J. Electroanal. Chem.*, vol. 662, no. 1, pp. 12–16, 2011.
- [108] M. Bassu, L. M. Strambini, and G. Barillaro, "Advances in electrochemical micromachining of silicon: Towards MEMS fabrication," *Procedia Eng.*, vol. 25, pp. 1653–1656, 2011.
- [109] Q. Abbas and L. Binder, "The electrochemical dissolution of molybdenum in non-aqueous media," *Int. J. Refract. Met. Hard Mater.*, vol. 29, no. 4, pp. 542–546, 2011.
- [110] Z. Xu, X. Chen, Z. Zhou, P. Qin, and D. Zhu, "Electrochemical machining of high-temperature titanium alloy Ti60," *Procedia CIRP*, vol. 42, no. ISEM XVIII, pp. 125–130, 2016.
- [111] V. Kirchner, L. Cagnon, R. Schuster, and G. Ertl, "Electrochemical machining of stainless steel microelements with ultrashort voltage pulses," *Appl. Phys. Lett.*, vol. 79, no. 11, pp. 1721–1723, 2001.
- [112] G. Meichsner, M. Hackert-Oschätzchen, T. Petzold, M. Kroenert, J. Edelmann, A. Schubert, and M. Putz, "Removal characteristic of stainless steel in pulsed electrochemical machining," in *International Symposium on Electrochemical Machining Technology 2016*, 2016, p. 73.
- [113] M. Schneider, N. Junker, E. Schroetke, and A. Michaelis, "ECM of a SiC-based ceramic- Passivation and Dissolution," in *International Symposium on Electrochemical Machining Technology 2016*, 2016, p. 93.
- [114] M. Schneider, N. Schubert, and A. Michaelis, "The dissolution mechanism of tungsten carbide under ECM

- conditions," in *International Symposium on Electrochemical Machining Technology 20162*, 2016, p. 107.
- [115] T. Kawanaka, S. Kato, M. Kunieda, J. W. Murray, and A. T. Clare, "Selective surface texturing using electrolyte jet machining," *Procedia CIRP*, vol. 13, no. October, pp. 345–349, 2014.
- [116] N. Shibuya, S. Watanabe, M. Kunieda, and N. Iwamoto, "Study on electrolyte jet turning," in *Proceedings of the 16th international symposium on electromachining*, 2010, pp. 347–350.
- [117] A. Martin, M. Hackert-Oschätzchen, and A. Schubert, "Design and realisation of a specific device for jet electrochemical machining of rotating workpieces," in *International Symposium on Electrochemical Machining Technology 20162*, 2016, p. 39.
- [118] T. Kawanaka and M. Kunieda, "Mirror-like finishing by electrolyte jet machining," *CIRP Ann. - Manuf. Technol.*, vol. 64, no. 1, pp. 237–240, 2015.
- [119] S. Kai, H. Sai, M. Kunieda, and H. Izumi, "Study on electrolyte jet cutting," *Procedia CIRP*, vol. 1, no. 1, pp. 627–632, 2012.
- [120] W. Natsu, S. Ooshiro, and M. Kunieda, "Research on generation of three-dimensional surface with micro-electrolyte jet machining," *CIRP J. Manuf. Sci. Technol.*, vol. 1, no. 1, pp. 27–34, 2008.
- [121] A. Martin, C. Eckart, N. Lehnert, M. Hackert-Oschätzchen, and A. Schubert, "Generation of Defined Surface Waviness on Tungsten Carbide by Jet Electrochemical Machining with Pulsed Current," *Procedia CIRP*, vol. 45, pp. 231–234, 2016.
- [122] M. Hackert-Oschätzchen, A. Martin, G. Meichsner, M. Zinecker, and A. Schubert, "Microstructuring of carbide metals applying Jet Electrochemical Machining," *Precis. Eng.*, vol. 37, no. 3, pp. 621–634, 2013.
- [123] N. K. Jain, A. Potpelwar, S. Pathak, and N. K. Mehta, "Investigations on geometry and productivity of micro-holes in Incoloy 800 by pulsed electrolytic jet drilling," *Int. J. Adv. Manuf. Technol.*, 2016.
- [124] M. Datta, D. Romankiw, D. R. Vigliotti, and R. Gutfeld, "Jet and laser-jet Electrochemical micromachining of nickel and steel," *J. Electrochem. Soc.*, vol. 136, no. 8, pp. 2251–2255, 1989.
- [125] M. Hackert-Oschätzchen, N. Lehnert, A. Martin, G. Meichsner, and A. Schubert, "Surface Characterization of Particle Reinforced Aluminum-matrix Composites Finished by Pulsed Electrochemical Machining," *Procedia CIRP*, vol. 45, no. June, pp. 351–354, 2016.
- [126] A. Schubert, U. Götze, M. Hackert-Oschätzchen, N. Lehnert, F. Herold, G. Meichsner, and A. Schmidt, "Evaluation of the Technical-Economic Potential of Particle- Reinforced Aluminum Matrix Composites and Electrochemical Machining," *IOP Conf. Ser. Mater. Sci. Eng.*, vol. 118, no. March, p. 10, 2016.
- [127] A. Martin, C. Eckart, N. Lehnert, M. Hackert-Oschätzchen, and A. Schubert, "Generation of Defined Surface Waviness on Tungsten Carbide by Jet Electrochemical Machining with Pulsed Current," *Procedia CIRP*, vol. 45, no. July, pp. 231–234, 2016.
- [128] A. Ruszaj, "Some aspects of electrochemical machining accuracy improvement," in *International Symposium on Electrochemical Machining Technology 20162*, 2016, p. 29.
- [129] A. R. Mount, K. L. Eley, and D. Clifton, "Theoretical analysis of chronoamperometric transients in electrochemical machining and characterization of titanium 6 / 4 and inconel 718 alloys," *J. Appl. Electrochem.*, vol. 30, pp. 447–455, 2000.
- [130] Y. Ferri, O. Piotrowski, P. F. Chauvy, C. Madore, and D. Landolt, "Two-level electrochemical micromachining of titanium for device fabrication," *J. Micromechanics Microengineering*, vol. 11, no. 5, pp. 522–527, 2001.
- [131] S. S. Anasane and B. Bhattacharyya, "Experimental investigation on suitability of electrolytes for electrochemical micromachining of titanium," *Int. J. Adv. Manuf. Technol.*, 2016.
- [132] D. Baehre, A. Ernst, K. Weißhaar, H. Natter, M. Stolpe, and R. Busch, "Electrochemical dissolution behavior of Titanium and Titanium-based alloys in different electrolytes," *Procedia CIRP*, vol. 42, no. Isem XVIII, pp. 137–142, 2016.
- [133] J. Mitchell-Smith and A. T. Clare, "Electrochemical jet machining of titanium: Overcoming passivation layers with ultrasonic assistance," *Procedia CIRP*, vol. 42, no. ISEM XVIII, pp. 379–383, 2016.
- [134] J. Pattavanitch and S. Hinduja, "Machining of turbulated cooling channel holes in turbine blades," *CIRP Ann. - Manuf. Technol.*, vol. 61, no. 1, pp. 199–202, 2012.
- [135] J. J. Maurer, J. J. Mallett, J. L. Hudson, S. E. Fick, T. P. Moffat, and G. A. Shaw, "Electrochemical micromachining of Hastelloy B-2 with ultrashort voltage pulses," *Electrochim. Acta*, vol. 55, pp. 952–958, 2010.
- [136] S. F. Huang and Y. Liu, "Electrochemical micromachining of complex shapes on nickel and nickel-based superalloys," *Mater. Manuf. Process.*, vol. 29, pp. 1483–1487, 2014.

- [137] M. Kunieda, K. Mizugai, S. Watanabe, N. Shibuya, and N. Iwamoto, "Electrochemical micromachining using flat electrolyte jet," *CIRP Ann. - Manuf. Technol.*, vol. 60, no. 1, pp. 251–254, 2011.
- [138] Y. Long, Q. Liu, Z. Zhong, L. Xiong, and T. Shi, "Experimental study on the processes of laser-enhanced electrochemical micromachining stainless steel," *Optik (Stuttg.)*, vol. 126, no. 19, pp. 1826–1829, 2015.
- [139] L. Guodong, L. Yong, K. Quancun, and T. Hao, "Selection and optimization of electrolyte for micro electrochemical machining on stainless steel 304," *Procedia CIRP*, vol. 42, no. ISEM XVIII, pp. 412–417, 2016.
- [140] A. Rebschläger, R. Kollmannsperger, and D. Bähre, "Video based process observations of the pulse electrochemical machining process at high current densities and small gaps," *Procedia CIRP*, vol. 14, no. HPC2014, pp. 418–423, 2014.
- [141] R. J. Leese and A. Ivanov, "Electrochemical micromachining: An introduction," *Spec. Issue Artic. Adv. Mech. Eng.*, vol. 8, no. 1, pp. 1–13, 2016.
- [142] C. Hui, Y.-K. Wang, Z.-L. Wang, and W.-S. Zhao, "Effects of Complexing Agent on Electrochemical Micro Machining of Stainless Steel," *Am. J. Nanotechnol.*, vol. 2, no. 1, pp. 100–105, 2011.
- [143] T. Sjöström and B. Su, "Micropatterning of titanium surfaces using electrochemical micromachining with an ethylene glycol electrolyte," *Mater. Lett.*, vol. 65, pp. 3489–3492, 2011.
- [144] Y. Yang, W. Natsu, and W. Zhao, "Realization of eco-friendly electrochemical micromachining using mineral water as an electrolyte," *Precis. Eng.*, vol. 35, no. 2, pp. 204–213, 2011.
- [145] B. Huaiqian, X. Jiawen, and L. Ying, "Aviation-oriented Micromachining Technology—Micro-ECM in Pure Water," *Chinese J. Aeronaut.*, vol. 21, no. 5, pp. 455–461, 2008.
- [146] S. H. Ryu, "Micro fabrication by electrochemical process in citric acid electrolyte," *J. Mater. Process. Technol.*, vol. 209, no. 6, pp. 2831–2837, 2009.
- [147] a. K. M. De Silva, H. S. J. S. J. Altena, J. a. McGeough, a.K.M. De Silva, H. S. J. S. J. Altena, and J. a. McGeough, "Influence of Electrolyte Concentration on Copying Accuracy of Precision-ECM," *CIRP Ann. - Manuf. Technol.*, vol. 52, no. 1, pp. 165–168, 2003.
- [148] B. Bhattacharyya and J. Munda, "Experimental investigation into electrochemical micromachining (EMM) process," *J. Mater. Process. Technol.*, vol. 140, pp. 287–291, 2003.
- [149] K. P. Rajurkar, G. Levy, A. Malshe, M. M. Sundaram, J. McGeough, X. Hu, R. Resnick, and A. DeSilva, "Micro and nano machining by electro-physical and chemical processes," *CIRP Ann. - Manuf. Technol.*, vol. 55, no. 2, pp. 643–666, 2006.
- [150] W. Wang, D. Zhu, N. S. Qu, S. F. Huang, and X. L. Fang, "Electrochemical drilling with vacuum extraction of electrolyte," *J. Mater. Process. Technol.*, vol. 210, no. 2, pp. 238–244, 2010.
- [151] D. Zhu, W. Wang, X. L. Fang, N. S. Qu, and Z. Y. Xu, "Electrochemical drilling of multiple holes with electrolyte-extraction," *CIRP Ann. - Manuf. Technol.*, vol. 59, no. 1, pp. 239–242, 2010.
- [152] X. Fang, N. Qu, Y. Zhang, Z. Xu, and D. Zhu, "Effects of pulsating electrolyte flow in electrochemical machining," *J. Mater. Process. Technol.*, vol. 214, no. 1, pp. 36–43, 2014.
- [153] X. Wang, N. Qu, X. Fang, and H. Li, "Electrochemical drilling with constant electrolyte flow," *J. Mater. Process. Technol.*, vol. 238, pp. 1–7, 2016.
- [154] M.-S. Han, B.-K. Min, and S. J. Lee, "Geometric improvement of electrochemical discharge micro-drilling using an ultrasonic-vibrated electrolyte," *J. Micromechanics Microengineering*, vol. 19, no. 6, p. 65004, 2009.
- [155] Z. Liu, Z. J. Qiu, C. Heng, and N. S. Qu, "Electrochemical Micro Drilling of Stainless Steel with Tool Electrode Jump Motion," *Mater. Sci. Forum*, vol. 626–627, pp. 333–338, 2009.
- [156] W. G. Clark and J. A. McGeough, "Temperature distribution along the gap in electrochemical machining," *J. Appl. Electrochem.*, vol. 7, no. 4, pp. 277–286, 1977.
- [157] J. Kozak, "Thermal models of pulse electrochemical machining," *Bull. Polish Acad. Sci. Tech. Sci.*, vol. 52, no. 4, pp. 313–320, 2004.
- [158] D. Deconinck, S. Van Damme, C. Albu, L. Hotoiu, and J. Deconinck, "Study of the effects of heat removal on the copying accuracy of the electrochemical machining process," *Electrochim. Acta*, vol. 56, no. 16, pp. 5642–5649, 2011.
- [159] V. K. Jain and A. K. Chouksey, "A comprehensive analysis of three-phase electrolyte conductivity during electrochemical macromachining / micromachining," *Proc. Inst. Mech. Eng. Part B J. Eng. Manuf.*, pp. 1–13, 2017.

- [160] J. Kozak, K. P. Rajurkar, and B. Wei, "Modelling and Analysis of Pulse Electrochemical Machining (PECM)," *J. Eng. Ind. - Trans. ASME*, vol. 116, no. 3, pp. 316–323, 1994.
- [161] L. Xu, Y. Pan, and C. Zhao, "Distance effects in electrochemical micromachining," *Sci. Rep.*, vol. 6, no. September, p. 31778, 2016.
- [162] D. S. Bilgi, V. K. Jain, R. Shekhar, and A. V. Kulkarni, "Hole quality and interelectrode gap dynamics during pulse current electrochemical deep hole drilling," *Int. J. Adv. Manuf. Technol.*, vol. 34, no. 1–2, pp. 79–95, 2007.
- [163] W. Zhang, T. Kitamura, M. Kunieda, and K. Abe, "Observation of ECM Gap Phenomena through Transparent Electrode," *Int. J. Electr. Mach.*, vol. 19, pp. 40–44, 2003.
- [164] H. P. Schulze, W. Schaetzing, T. Gmelin, and M. Leone, "Presentation: Influence of gas bubble when using  $\mu$ PECM," in *Otto Von Guericke, University Magdeburg, Germany*, 2015, no. August.
- [165] H. P. Schulze and W. Schätzing, "Influences of different contaminations on the electro-erosive and the electrochemical micro-machining," *Procedia CIRP*, vol. 6, pp. 58–63, 2013.
- [166] G. Mayank and M. Kuneida, "Two- Phase Simulation of Electrochemical Machining," *Int. J. Electr. Mach.*, vol. 22, pp. 31–35, 2017.
- [167] K. P. Rajurkar, J. Kozak, B. Wei, and J. A. McGeough, "Study of pulse electrochemical machining characteristics," *CIRP Ann. - Manuf. Technol.*, vol. 42, no. 1, pp. 231–234, 1993.
- [168] H.-P. Schulze, M. Herzig, and O. Kroening, "Differentiation of process energy sources (PES) in pulsed electrochemical machining (PECM) based on their controllability," in *International Symposium on Electrochemical Machining Technology 2016*, 2016, pp. 15–20.
- [169] H.-P. Schulze, A. Ruszaj, T. Gmelin, J. Kozak, K. Karbowski, D. Borkenhagen, and M. Leone, "Study of the Process Accuracy of the Electrochemical Micro Machining Using Ultra Nanosecond and Short Microsecond Pulses," *Proc. 16th Int. Symp. Electromachining*, vol. 1, no. ISEM XVI, p. 6, 2010.
- [170] Y. J. Zhang, Y. J. Tang, X. K. Liu, Z. N. Guo, and F. Li, "Development of Ultra-Short Pulse Power Supply Applicable to Micro-ECM," in *Materials Science Forum*, 2009, vol. 626–627, pp. 369–374.
- [171] A. Spieser and A. Ivanov, "Design of a pulse power supply unit for micro ECM," *Int. J. Adv. Manuf. Technol.*, vol. 78, pp. 537–547, 2015.
- [172] S. Burkert, H. P. Schulze, T. Gmelin, and M. Leone, "The pulse electrochemical micromachining (PECM): Specifications of the pulse units," *Int. J. Mater. Form.*, vol. 2, no. SUPPL. 1, pp. 645–648, 2009.
- [173] K. Yamaguchi and W. Natsu, "Proposal of pulse power supply with raised low-level voltage for accuracy improvement in wire ECM," in *Proceedings of the 14th euspen International Conference -Dubrovnik*, 2014, pp. 103–106.
- [174] N. Giandomenico and O. Meylan, "Development of a New Generator for Electrochemical Micro-machining," *Procedia CIRP*, vol. 42, no. Isem Xviii, pp. 804–808, 2016.
- [175] Y. Zhang, Z. Xu, Y. Zhu, and D. Zhu, "Effect of tube-electrode inner structure on machining performance in tube-electrode high-speed electrochemical discharge drilling," *J. Mater. Process. Technol.*, vol. 231, pp. 38–49, 2016.
- [176] M. Machida and W. Natsu, "Flow analysis of working fluid in micro electrical discharge drilling process," in *Proceedings of the 14th euspen International Conference -Dubrovnik*, 2014, pp. 107–111.
- [177] D. Zhu and H. Y. Xu, "Improvement of electrochemical machining accuracy by using dual pole tool," *J. Mater. Process. Technol.*, vol. 129, pp. 15–18, 2002.
- [178] W. Wang, D. Zhu, N. Qu, S. Huang, and X. Fang, "Electrochemical drilling inclined holes using wedged electrodes," *Int. J. Adv. Manuf. Technol.*, vol. 47, no. 9–12, pp. 1129–1136, 2010.
- [179] D. Sheu, "Micro-spherical probes machining by EDM," *J. Micromechanics Microengineering*, vol. 15, pp. 185–189, 2005.
- [180] X. Fang, N. Qu, Y. Zhang, Z. Xu, and D. Zhu, "Improvement of hole exit accuracy in electrochemical drilling by applying a potential difference between an auxiliary electrode and the anode," *J. Mater. Process. Technol.*, vol. 214, no. 3, pp. 556–564, 2014.
- [181] W. Liu, S. Ao, Y. Li, Z. Liu, H. Zhang, Z. Luo, and H. Yu, "Investigation on the profile of microhole generated by electrochemical micromachining using retracted tip tool," *Int. J. Adv. Manuf. Technol.*, no. 92, pp. 1–13, 2016.
- [182] D. Mi and W. Natsu, "Simulation of Micro ECM for complex-shaped holes," *Procedia CIRP*, vol. 42, no. ISEM XVIII, pp. 345–349, 2016.

- [183] V. V. Lyubimov, V. M. Volgin, U. Mescheder, I. V. Gnidina, and A. S. Ivanov, "Investigation of plastic electrode tools for electrochemical machining of silicon," *Precis. Eng.*, vol. 47, pp. 546–556, 2017.
- [184] W. L. Eisberg, "US Patent: Tube holding means for electrochemical machining apparatus," 3467592, 1969.
- [185] Y. Liu, D. Zhu, Y. Zeng, and H. Yu, "Development of microelectrodes for electrochemical micromachining," *Int. J. Adv. Manuf. Technol.*, vol. 55, no. 1–4, pp. 195–203, 2011.
- [186] I. Yang, M. S. Park, and C. N. Chu, "Micro ECM with ultrasonic vibrations using a semi-cylindrical tool," *Int. J. Precis. Eng. Manuf.*, vol. 10, no. 2, pp. 5–10, 2009.
- [187] Z. W. Fan and L. W. Hourng, "The analysis and investigation on the microelectrode fabrication by electrochemical machining," *Int. J. Mach. Tools Manuf.*, vol. 49, no. 7–8, pp. 659–666, 2009.
- [188] Z. Liu, Y. Liu, Z. J. Qiu, and N. Qu, "Effect of tool electrode insulation on electrochemical micro drilling accuracy," *Nanotechnol. Precis. Eng.*, vol. 7, no. 4, pp. 355–360, 2009.
- [189] E. Ferraris, V. Castiglioni, F. Ceysens, M. Annoni, B. Lauwers, and D. Reynaerts, "Manufacturing Technology EDM drilling of ultra-high aspect ratio micro holes with insulated tools," *CIRP Ann. - Manuf. Technol.*, vol. 62, no. 1, pp. 191–194, 2013.
- [190] G. H. Liu, Y. Li, X. P. Chen, and S. J. Lv, "Research on Side-Insulation of Tool Electrode for Micro Electrochemical Machining," *Adv. Mater. Res.*, vol. 60–61, pp. 380–387, 2009.
- [191] A. Brusilovski, "Dielectric Coating of Cathodes for Microfabrication Using Electrochemical Method," *J. Manuf. Sci. Eng. Asme*, vol. 132, no. 6, p. 64505, 2010.
- [192] J. Wang, W. Chen, F. Gao, and F. Han, "A new electrode sidewall insulation method in electrochemical drilling," *Int. J. Adv. Manuf. Technol.*, vol. 75, no. 1–4, pp. 21–32, 2014.
- [193] A. K. Swain, M. M. Sundaram, and K. P. Rajurkar, "Use of coated microtools in advanced manufacturing: An exploratory study in electrochemical machining (ECM) context," *J. Manuf. Process.*, vol. 14, no. 2, pp. 150–159, 2012.
- [194] A. K. Swain, "Preparation of Coated Microtools for Electrochemical Machining Applications," in *MS Thesis, IMSE, University of Nebraska-Lincoln*, 2010.
- [195] B. Lauwers, F. Klocke, A. Klink, A. E. Tekkaya, R. Neugebauer, and D. McIntosh, "Hybrid processes in manufacturing," *CIRP Ann. - Manuf. Technol.*, vol. 63, pp. 561–583, 2014.
- [196] G. Schuh, J. Kreysa, and S. Orilski, "Roadmap „Hybride Produktion“,“ *ZWF Zeitschrift für wirtschaftlichen Fabrikbetr.*, vol. 104, no. 5, pp. 385–391, May 2009.
- [197] A. Stephen, "Mechanisms and applications of laser chemical machining," *Phys. Procedia*, vol. 12, no. PART 2, pp. 261–267, 2011.
- [198] S. Hopman, A. Fell, K. Mayer, A. Rodofili, and F. Granek, "Microstructuring and wafering of silicon with laser chemical processing," *Spie Lase*, vol. 7585, p. 75850S–75850S–15, 2010.
- [199] M. Takai, S. Nagatomo, H. Kohda, C. Yada, H. Sandaiji, and F. Takeya, "Laser chemical processing of magnetic materials for recording-head application," *Appl. Phys. A Solids Surfaces*, vol. 58, no. 4, pp. 359–363, 1994.
- [200] M. R. Rafzar, J. Ni, A. Behroozfar, and S. Lan, "An investigation on electrochemical discharge micro-drilling of glass," in *Proceedings of the ASME 2013 International Manufacturing Science and Engineering Conference MSEC2013 June 10-14, 2013, Madison, Wisconsin, USA*, 2016, pp. 1–7.
- [201] W. Wang, Z. X. Liu, W. Zhang, Y. H. Huang, and D. M. Allen, "Abrasive electrochemical multi-wire slicing of solar silicon ingots into wafers," *CIRP Ann. - Manuf. Technol.*, vol. 60, no. 1, pp. 255–258, 2011.
- [202] D. T. Curtis, S. L. Soo, D. K. Aspinwall, and C. Sage, "Electrochemical superabrasive machining of a nickel-based aeroengine alloy using mounted grinding points," *CIRP Ann. - Manuf. Technol.*, vol. 58, no. 1, pp. 173–176, 2009.
- [203] A. K. M. De Silva, H. P. Schulze, G. Wollenberg, T. K. K. R. Mediliyegedara, M. Zybura, and G. Skrabalak, "High Aspect Ratio Hole Sinking by Hybrid Electrochemical Discharge Machining ( ELESIN )," *Ann. CIRP*, vol. 55, no. March, 2006.
- [204] H. Zhang, J. Xu, and J. Wang, "Investigation of a novel hybrid process of laser drilling assisted with jet electrochemical machining," *Opt. Lasers Eng.*, vol. 47, no. 11, pp. 1242–1249, 2009.
- [205] Y. Zhang, Z. Xu, D. Zhu, and J. Xing, "Tube electrode high-speed electrochemical discharge drilling using low-conductivity salt solution," *Int. J. Mach. Tools Manuf.*, vol. 92, pp. 10–18, 2015.
- [206] J. Wang, W. Chen, F. Gao, and F. Han, "Ultrasonically assisted electrochemical micro drilling with sidewall-insulated electrode," *Proc. Inst. Mech. Eng. Part B J. Eng. Manuf.*, vol. 230, no. 3, pp. 466–474, 2016.

- [207] S. Skoczypiec, "Research on ultrasonically assisted electrochemical machining process," *Int. J. Adv. Manuf. Technol.*, vol. 52, no. 5–8, pp. 565–574, 2011.
- [208] M. Coteață, N. Pop, H.-P. Schulze, L. Slătineanu, and O. Dodun, "Investigation on hybrid electrochemical discharge drilling process using passivating electrolyte," *Procedia CIRP*, vol. 42, no. ISEM XVIII, pp. 778–782, 2016.
- [209] Z. Zhang, Q. Feng, M. Cai, L. Huang, and Y. Jiang, "Research on stress-etching complex microstructure of aluminum alloy in laser electrochemical machining," *Int. J. Adv. Manuf. Technol.*, vol. 81, no. 9–12, pp. 2157–2165, 2015.
- [210] L. Yuan, J. Xu, J. Zhao, and H. Zhang, "Research on hybrid process of laser drilling with jet electrochemical machining," *J. Manuf. Sci. Eng.*, vol. 134, no. 64502, pp. 1–4, 2012.
- [211] Z. Hua and X. Jiawen, "Modeling and Experimental Investigation of Laser Drilling with Jet Electrochemical Machining," *Chinese J. Aeronaut.*, vol. 23, no. 4, pp. 454–460, 2010.
- [212] L. Li and C. Achara, "Chemical Assisted Laser Machining for The Minimisation of Recast and Heat Affected Zone," *CIRP Ann. - Manuf. Technol.*, vol. 53, no. 1, pp. 175–178, 2004.
- [213] R. Nowak, S. Metev, and G. Sepold, "Nd:YAG-laser-induced wet chemical etching of titanium and stainless steel," *Sensors and Actuators: A. Physical*, vol. 51, no. 1, pp. 41–45, 1995.
- [214] S. Skoczypiec, "Application of laser and electrochemical interaction in sequential and hybrid micromachining processes," *Bull. Polish Acad. Sci. Tech. Sci.*, vol. 63, no. 1, pp. 305–314, 2015.
- [215] T. Kurita, S. Watanabe, and M. Hattori, "Development of hybrid micro machine tool," *Proc. - 2nd Int. Symp. Environ. Conscious Des. Inverse Manuf.*, pp. 797–802, 2001.
- [216] P. T. Pajak, A. K. M. Desilva, D. K. Harrison, and J. A. McGeough, "Precision and efficiency of laser assisted jet electrochemical machining," *Precis. Eng.*, vol. 30, pp. 288–298, 2006.
- [217] A. K. M. De Silva, P. T. Pajak, J. A. McGeough, and D. K. Harrison, "Thermal effects in laser assisted jet electrochemical machining," *CIRP Ann. - Manuf. Technol.*, vol. 60, no. 1, pp. 243–246, 2011.
- [218] P. T. Pajak, A. K. M. De Silva, D. K. Harrison, and J. a. McGeough, "Process Energy Analysis for Aluminium Alloy and Stainless Steel in Laser-Assisted Jet Electrochemical Machining," *Proc. Inst. Mech. Eng. Part B J. Eng. Manuf.*, vol. 220, no. 3, p. S. 405-412, 2006.
- [219] Z. Liu, H. Nouraei, J. K. Spelt, and M. Papini, "Electrochemical slurry jet micro-machining of tungsten carbide with a sodium chloride solution," *Precis. Eng.*, vol. 40, pp. 189–198, 2015.
- [220] H. Zhang, J. W. Xu, and J. M. Wang, "Green Laser Drilling Assisted with Jet Electrochemical Machining of Nickel-based Superalloy," *Key Eng. Mater.*, vol. 426–427, pp. 75–80, 2010.
- [221] D. Van Camp, J. Bouquet, J. Qian, J. Vleugels, and B. Lauwers, "Investigation on hybrid mechano-electrochemical milling of Ti6Al4V (accepted)," *Procedia CIRP ISEM2018*, 2018.
- [222] T. Singh and A. Dvivedi, "Developments in electrochemical discharge machining: A review on electrochemical discharge machining, process variants and their hybrid methods," *Int. J. Mach. Tools Manuf.*, vol. 105, pp. 1–13, 2016.
- [223] T. K. K. R. Mediliyedara, A. K. M. De Silva, D. K. Harrison, and J. A. McGeough, "New developments in the process control of the hybrid electro chemical discharge machining (ECDM) process," *J. Mater. Process. Technol.*, vol. 167, pp. 338–343, 2005.
- [224] M. Goud, A. K. Sharma, and C. Jawalkar, "A review on material removal mechanism in electrochemical discharge machining (ECDM) and possibilities to enhance the material removal rate," *Precis. Eng.*, vol. 45, pp. 1–17, 2016.
- [225] M. Schöpf, I. Beltrami, M. Boccadoro, D. Kramer, and B. Schumacher, "ECDM (Electro Chemical Discharge Machining), a new method for trueing and dressing of metal bonded diamond grinding tools," *CIRP Ann. - Manuf. Technol.*, vol. 50, no. 1, pp. 125–128, 2001.
- [226] C. P. Cheng, K. L. Wu, C. C. Mai, C. K. Yang, Y. S. Hsu, and B. H. Yan, "Study of gas film quality in electrochemical discharge machining," *Int. J. Mach. Tools Manuf.*, vol. 50, no. 8, pp. 689–697, 2010.
- [227] B. Jiang, S. Lan, K. Wilt, and J. Ni, "Modeling and experimental investigation of gas film in micro-electrochemical discharge machining process," *Int. J. Mach. Tools Manuf.*, vol. 90, pp. 8–15, 2015.
- [228] B. R. Sarkar, B. Doloi, and B. Bhattacharyya, "Parametric analysis on electrochemical discharge machining of silicon nitride ceramics," *Int. J. Adv. Manuf. Technol.*, vol. 28, no. 9–10, pp. 873–881, 2006.
- [229] M. Coteață, H. P. Schulze, N. Pop, I. Beșliu, and L. Slătineanu, "Machinability of a stainless steel by electrochemical discharge microdrilling," *AIP Conf. Proc.*, vol. 1353, no. 2011, pp. 1356–1360, 2011.

- [230] M. Coteață, H.-P. Schulze, and L. Slătineanu, "Drilling of Difficult-to-Cut Steel by Electrochemical Discharge Machining," *Mater. Manuf. Process.*, vol. 26, no. 12, pp. 1466–1472, 2011.
- [231] S. K. Jui, A. B. Kamaraj, and M. M. Sundaram, "High aspect ratio micromachining of glass by electrochemical discharge machining (ECDM)," *J. Manuf. Process.*, vol. 15, no. 4, pp. 460–466, 2013.
- [232] J. West and A. Jadhav, "ECDM methods for fluidic interfacing through thin glass substrates and the formation of spherical microcavities," *J. Micromechanics Microengineering*, vol. 17, no. 2, pp. 403–409, 2007.
- [233] D. J. Kim, Y. Ahn, S. H. Lee, and Y. K. Kim, "Voltage pulse frequency and duty ratio effects in an electrochemical discharge microdrilling process of Pyrex glass," *Int. J. Mach. Tools Manuf.*, vol. 46, no. 10, pp. 1064–1067, 2006.
- [234] Y. S. Liao and W. Y. Peng, "Study of Hole-Machining on Pyrex Wafer by Electrochemical Discharge Machining (ECDM)," *Mater. Sci. Forum*, vol. 505–507, pp. 1207–1212, 2006.
- [235] S. K. Chak and P. Venkateswara Rao, "Trepanning of Al<sub>2</sub>O<sub>3</sub> by electro-chemical discharge machining (ECDM) process using abrasive electrode with pulsed DC supply," *Int. J. Mach. Tools Manuf.*, vol. 47, no. 14, pp. 2061–2070, 2007.
- [236] K. H. Nguyen, P. A. Lee, and B. H. Kim, "Experimental investigation of ECDM for fabricating micro structures of quartz," *Int. J. Precis. Eng. Manuf.*, vol. 16, no. 1, pp. 5–12, 2015.
- [237] H. P. Schulze, M. Lauter, G. Wollenberg, M. Zybura-Skrabalak, and A. K. M. De Silva, "Process Energy Sources for the Electrochemical Machining Process and Hybrid Machining with ECM," *Proc. 3rd Int. Conf. Mach. Sculpt. Surfaces*, vol. Krakow, no. September, pp. 367–378, 2003.
- [238] R. Wüthrich, L. A. Hof, A. Lal, K. Fujisaki, H. Bleuler, P. Mandin, and G. Picard, "Physical principles and miniaturization of spark assisted chemical engraving (SACE)," *J. Micromechanics Microengineering*, vol. 15, no. 10, p. S268, 2005.
- [239] P. Maillard, B. Despont, H. Bleuler, and R. Wüthrich, "Geometrical characterization of micro-holes drilled in glass by gravity-feed with spark assisted chemical engraving (SACE)," *J. Micromechanics Microengineering*, vol. 17, no. 7, pp. 1343–1349, 2007.
- [240] V. A. Mogilnikov, M. Y. Chmir, Y. S. Timofeev, and V. S. Poluyanov, "Diamond - ECM grinding of ceramic-metal tungsten," *Procedia CIRP*, vol. 6, pp. 407–409, 2013.
- [241] A. Stephen and F. Vollertsen, "Mechanisms and processing limits in laser thermochemical machining," *CIRP Ann. - Manuf. Technol.*, vol. 59, no. 1, pp. 251–254, 2010.
- [242] Y. Hibi, Y. Enomoto, K. Kikuchi, N. Shikata, and H. Ogiso, "Excimer laser assisted chemical machining of SiC ceramic," *Appl. Phys. Lett.*, vol. 817, p. 817, 1995.
- [243] A. Ruszaj, M. Zybura, R. Żurek, and G. Skrabalak, "Some aspects of the electrochemical machining process supported by electrode ultrasonic vibrations optimization," *Proc. Inst. Mech. Eng. Part B J. Eng. Manuf.*, vol. 217, pp. 1365–1371, 2003.
- [244] P. Sapre, A. Mall, and S. S. Joshi, "Analysis of electrolytic flow effects in micro-electrochemical grinding," *J. Manuf. Sci. Eng.*, vol. 135, pp. 1–9, 2013.



## Acknowledgements

This work was carried out under the framework of Horizon 2020 Marie Curie ITN European project “Process Fingerprint for Zero-defect Net-shape MICROMANufacturing”. The authors would like to acknowledge financial support received from Microman project Grant# 674801.

**Highlights**

- The studies related to electrochemical micromachining and its hybrid variants have been reviewed.
- Both fundamental and applied research developments have been presented.
- Future research potential of micro-ECM and its hybrid variants is pointed.